

O W N E R ' S M A N U A L



PARASOUND

AVC-1800 Audio Video Controller

all-guides.com



Table of Contents

Important Safety Instructions	4
Introduction	9
About this Manual	9
AVC-1800 Rear Panel Drawing	10
AVC-1800 Front Panel Drawing.....	12
AVC-1800 Main Zone Remote Drawing	14
AVC-1800 Remote Zone Remote Drawing.....	16
Making Connections to Your AVC-1800	17
AVC-1800 Input and Output Connection Drawing	18
AVC-1800 Front Panel Controls	22
AVC 1800 Remote Control Buttons	25
Surround Processing Modes	27
AVC-1800 On-screen Display.....	29
Placement of Your Home Theater Speakers.....	29
Setting up your AVC 1800	32
Bass Management Settings	32
Calibrating Channel Levels.....	33
Programming the Learning Remote Control.....	34
Operating Your AVC-1800	36
Using the Tuner	36
Operating the Remote Zone	38
Maintaining Your AVC-1800	38
In Case of Trouble	38
Blank Remote Control Drawings	40
AVC-1800 Specifications	43

Record the following information for future reference:

Serial # _____ Date of Purchase _____

Parasound Dealer _____

Parasound Dealer's Phone Number _____

AVC-1800 Audio Video Controller Features

- Full 24 bit Processing Using Crystal Semiconductor CS4926
- Dolby Digital Dolby Pro Logic, and DTS Decoding
- Three Burr-Brown PCM 1716 D to A Converters
- Reference Quality FM/AM Stereo Tuner with 29 Presets
- Digital Inputs and Surround Modes are Assignable to Sources
- Four Audio/Video Inputs with Composite and S-Video Connectors
- On-screen Display and Front Panel Indicators
- Illuminated, Eight Source Learning Remote Control
- Separate Rear Panel Infrared Input Connectors for Main and Zone
- Dual Zone Audio Controller With Separate 12 Volt DC Trigger
- 5.1 Analog Input for Future Format Compatability

Licensing Acknowledgements



Manufactured under license from Dolby Laboratories Licensing Corporation. "Dolby", "Pro Logic", and the double-D symbol are trademarks of Dolby Laboratories Licensing Corporation. Copyright 1992 Dolby Laboratories, Inc. All Rights Reserved



Manufactured under license from Digital Theater Systems, Inc. US Pat. No. 5,451,942 and other worldwide patents issued and pending. "DTS", "DTS Digital Surround", are trademarks of Digital Theater Systems, Inc. Copyright 1996 Digital Theater Systems, Inc. All Rights Reserved.

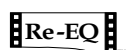

Manufactured under license from Lucasfilm Ltd. U.S. patent numbers 5,043,970; 5,189,703; and 5,222,059.

Important Safety Instructions

Save these instructions for future use



This triangle alerts you to the dangerous voltages inside that may be a shock hazard.



This triangle alerts you to important operating and maintenance instructions in this manual.

- ✓ Follow all instructions and warnings marked on the unit.
- ✓ Always use with the correct line voltage. Refer to the manufacturer's operating instructions for power requirements. Be advised that different operating voltages may require the use of a different line cord and/or attachment plug.
- ✓ Do not install the unit in an unventilated rack, or directly above heat producing equipment such as power amplifiers. Observe the maximum ambient operating temperature listed in the product specification.
- ✓ Slots and opening on the case are provided for ventilation; to ensure reliable operation and prevent it from overheating, these openings must not be blocked or covered. Never push objects of any kind through the ventilation slots. Never spill a liquid of any kind on the unit.
- ✓ Never attach audio power amplifier outputs directly to any of the unit's connectors.
- ✓ To prevent shock or fire hazard, do not expose the unit to rain or moisture, or operate it where it will be exposed to water.
- ✓ Do not attempt to operate the unit if it has been dropped, damaged, exposed to liquids, or if it exhibits a distinct change in performance indicating the need for service.
- ✓ This unit should only be opened by qualified service personnel. Removing covers will expose you to hazardous voltages.
- ✓ Adhere to all warnings on the unit and in the operating instructions.
- ✓ Take precautions not to defeat the grounding or polarization of the units power cord.
- ✓ Do not overload wall outlet, extension cords or integral convenience receptacles, as this can result in a risk of fire or electrical shock.
- ✓ Route power supply cords so that they are not likely to be walked on or pinched by items placed on or against them, paying particular attention to cords at plugs, convenience receptacles, and the point at which they exit from the unit.
- ✓ The unit should be cleaned only as recommended.

Communications Notice

This equipment generates and uses radio frequency energy and if not installed and used properly, that is, in strict accordance with the manufacturer's instructions, may cause interference to radio and television reception. It has been type tested and found to comply with the limits for a Class B computing device in accordance with the specifications in Subpart J of Part 15 of FCC Rules, which are designated to provide reasonable protection against such interference in a residential installation. However, there is no guarantee that interference will not occur in a particular installation. If this equipment does cause interference to radio or television reception, which can be determined by turning the equipment OFF and ON, the user is encouraged to try to correct the interference by one or more of the following measures:

- ✓ Reorient the television receiving antenna
- ✓ Relocate the AVC-2500 away from the television
- ✓ Plug the AVC-2500 into a different AC outlet so that the AVC-2500 and television are on different branch circuits.

If necessary, the user should consult the dealer or an experienced radio/television technician for additional suggestions. The user may find the following booklet prepared by the Federal Communications Commission helpful: "How to identify and Resolve Radio/TV Interference Problems." This booklet is available from the U.S. Government printing office, Washington, DC 20402, Stock No.004-000-00345-4.

Le présent appareil numérique n' émet pas de bruits radioélectriques dépassant les limites applicables aux appareils numériques de la class B prescrites dans le Règlement sur le brouillage radioélectrique édicté par le ministère des Communications du Canada.



Español

Instrucciones Importantes de Seguridad

Guarde estas instrucciones para uso posterior. Utilice siempre el voltaje correcto. Diríjase a las instrucciones de operación del fabricante para obtener las especificaciones de potencia. Esté al tanto de que voltajes de operación distintos requieren el uso de cables y/o enchufes distintos.

No instale esta unidad en un estante sin ventilación, ni tampoco directamente encima de equipos que generen calor tales como amplificadores de potencia. Fíjese en las temperaturas ambientales máximas de operación que se mencionan en las especificaciones del producto.

Las aperturas y ranuras del chasis sirven para proveer a ventilación necesaria para operar la unidad con seguridad y para prevenir sobrecalentamiento, y por lo tanto no pueden ser obstruidas o cubiertas. No introduzca objetos de ningún tipo a través de las ranuras de ventilación, y nunca deje caer ningún líquido sobre la unidad.

Nunca conecte ningún tipo de salida de amplificadores de sonido directamente a los conectores de la unidad.

Para prevenir descargas eléctricas o incendios, mantenga la unidad alejada de la lluvia, humedad o cualquier lugar en el que pueda entrar en contacto con agua.

No trate de hacer funcionar la unidad si se ha caído, está dañada, ha entrado en contacto con líquidos, o si nota cualquier cambio brusco en su funcionamiento que indique la necesidad de hacerle un servicio de mantenimiento.

Esta unidad deberá ser abierta por personal calificado. Si usted quita las coberturas se expondrá a voltajes peligrosos.



Este triángulo que aparece en su componente le advierte sobre la existencia dentro del chasis de voltajes peligrosos sin aislantes ... voltajes que son lo suficientemente grandes como para causar electrocución.



Este triángulo que aparece en su componente lo alerta sobre las instrucciones de operación y mantenimiento importantes que están en los materiales de lectura que se incluyen.

Français

Instructions de Sécurité Importantes

Gardez ces instructions pour référence future.

Observez toutes les instructions et tous les avertissements marqués sur l'appareil.

Branchez uniquement sur un réseau de tension indiquée. Consultez le manuel d'instruction du fabricant pour les spécifications de courant. N'oubliez pas que différentes tensions peuvent nécessiter l'utilisation de câbles et/ou de fiches de connexion différents.

N'installez pas l'appareil en un compartiment non-aéré ou directement au-dessus d'équipements générateurs de chaleur, tels qu'amplificateurs de courants, etc. Ne dépassez pas la température ambiante maximale de fonctionnement indiquée dans les spécifications du produit.

Des fentes et ouvertures sont prévues dans le boîtier pour l'aération; Pour assurer le bon fonctionnement et pour prévenir l'échauffement, ces ouvertures ne doivent pas être couvertes ou bloquées. N'insérez pas d'objets dans les fentes d'aération. Empêchez tout liquide de se répandre sur l'appareil.

Ne connectez jamais d'amplificateurs audio directement aux connecteurs de l'appareil.

Pour empêcher les chocs électriques et le danger d'incendie, évitez d'exposer l'appareil à la pluie ou à l'humidité, et ne le mettez pas en marche en un endroit où il serait exposé aux éclaboussures d'eau.

N'essayez pas de faire fonctionner l'appareil s'il est tombé à terre, a été endommagé, exposé à un liquide, ou si vous observez des différences nettes dans son fonctionnement, indiquant la nécessité de réparations.

Cet appareil ne doit être ouvert que par un personnel de service qualifié. En enlevant les couvercles vous vous exposez à des tensions électriques dangereuses.



Ce triangle, sur votre appareil vous avertit de la présence de tension dangereuse, non-isolée à l'intérieur du boîtier.. une tension suffisante pour représenter un danger d'électrocution.



Ce triangle sur votre appareil vous invite de suivre d'importantes instructions d'utilisation et d'entretien dans la documentation livrée avec le produit.

Deutsch

Wichtige Sicherheitsanweisungen

Heben Sie sich diese Sicherheitsanweisungen auch für später auf.

Befolgen Sie alle auf der Vorrichtung stehenden Anweisungen und Warnungen. Immer nur mit der richtigen Spannung verwenden! Die Gebrauchsanweisungen des Herstellers informieren Sie über die elektrischen Anforderungen. Vergessen Sie nicht daß bei verschiedenen Betriebsspannungen ggf. auch verschiedene Leitungskabel und/oder Verbindungsstecker zu verwenden sind.

Stellen Sie die Vorrichtung nicht in ein unbelüftetes Gestell oder unmittelbar über wärmeerzeugende Geräte wie z.B. Tonverstärker. Halten Sie die In den Produktspezifikationen angegebene maximale Umgebungstemperatur bei Betrieb ein.

Schlitze und Öffnungen im Gehäuse dienen der Belüftung; um verlässlichen Betrieb sicherzustellen und Überheizen zu vermeiden dürfen diese Öffnungen nicht verstopft oder abgedeckt werden. Stecken Sie nie irgend einen Gegenstand durch die Belüftungsschlitze. Vergießen Sie keine Flüssigkeiten auf den Apparat.

Schließen Sie nie Tonverstärker unmittelbar an einen Anschluß des Apparates an.

Um elektrischen Schlag oder Feuer zu vermeiden, setzen Sie den Apparat weder Regen noch Feuchtigkeit aus und betreiben Sie ihn nicht dort wo Wasser eindringen könnte.

Versuchen Sie nicht den Apparat zu betreiben falls er fallen gelassen, beschädigt, oder Flüssigkeiten ausgesetzt wurde, oder falls sich seine Arbeitsweise derart ändert daß daraus ein Bedarf nach Reparatur zu schließen ist.

Dieser Apparat sollte nur von qualifizierten Fachleuten geöffnet werden. Das Abnehmen von Abdeckungen setzt Sie gefährlichen Spannungen aus.



Dieses Dreieck auf Ihrem Apparat warnt Sie vor nicht-isolierter, gefährlicher Spannung im Gehäuse stark genug um eine Benährungsgefahr darzustellen.



Dieses Dreieck auf Ihrem Apparat bedeutet daß wichtige Betriebs- und Wartungsanweisungen in der mitgelieferten Dokumentation zu finden sind.

Italiano

Importanti norme di sicurezza

Conservare le presenti norme per l'uso futuro.

Osservare tutte le istruzioni e le avvertenze apposte sull'unità.

Utilizzare esclusivamente con la tensione di rete corretta. Consultare le istruzioni operative fornite dal fabbricante per i dati riguardanti la tensione e l'assorbimento di corrente. Potrebbe essere necessario l'uso di cavi di rete e/o di spine diverse a seconda della tensione utilizzata.

Non installare l'unità in uno scaffale privo di ventilazione oppure direttamente sopra una fonte di calore, come, ad esempio, un amplificatore. Non superare la temperatura ambientale massima di funzionamento riportata nei dati tecnici del prodotto.

Le fessure e le altre aperture nella scatola servono alla ventilazione. Per un funzionamento affidabile, e per evitare un eventuale surriscaldamento, queste aperture non vanno ostruite o coperte in nessun modo. Evitare in tutti i casi di inserire oggetti di qualsiasi genere attraverso le fessure di ventilazione. Non versare mai del liquido di nessun tipo sull'unità.

Evitare sempre di collegare le uscite dell'amplificatore audio direttamente ai connettori dell'unità.

Per prevenire il pericolo di folgorazione e di incendio non esporre l'unità alla pioggia o ad un'umidità eccessiva; evitare di adoperare l'unità dove potrebbe entrare in contatto con acqua.

Evitare di adoperare l'unità se la stessa è stata urtata violentemente, se ha subito un danno, se è stata esposta ad un liquido o in caso di un evidente cambiamento delle prestazioni che indichi la necessità di un intervento di assistenza tecnica.

Ogni intervento sull'unità va eseguito esclusivamente da personale qualificato. La rimozione della copertura comporta l'esposizione al pericolo di folgorazione.



Il presente triangolo impresso sul componente avverte della presenza di tensioni pericolose non isolate all'interno della copertura... tali tensioni rappresentano un pericolo di folgorazione.



Il presente triangolo impresso sul componente avverte l'utente della presenza nella allegata di importanti istruzioni relative al funzionamento ed alla manutenzione.

Dansk

Vigtig information om sikkerhed

Gem denne Vejledning til senere brug.
Følg alle anvisninger og advarsler på apparatet.

Apparatet skal altid tilsluttes den korrekte spænding. Der henvises til brugsanvisningen, der indeholder specifikationer for strømforsyning. Der gøres opmærksom på, at ved varierende driftsspændinger kan det blive nødvendigt at bruge andre lednings- og/eller stiktyper.

Apparatet må ikke monteres i et kabinet uden ventilation eller lige over andet udstyr der udvikler varme, f.eks. forstærkere. Den maksimale omgivelsestemperatur ved drift, der står opført i specifikationerne, skal overholdes.

Der er ventilationsåbninger i kabinettet. For at sikre apparatets drift og hindre overophedning må disse åbninger ikke blokeres eller tildekkes. Stik aldrig noget ind igennem ventilationsåbningerne, og pas på aldrig at spilde nogen form for væske på apparatet.

Udgangsstik fra audioforstærkere må aldrig sættes direkte i apparatet.

Apparatet må ikke udsættes for regn eller fugt og må ikke bruges i nærheden af vand for at undgå risiko for elektrisk stød og brand.

Apparatet må aldrig bruges, hvis det er blevet stødt, beskadiget eller vådt, eller hvis ændringer i ydelsen tyder på, at det trænger til eftersyn.

Dette apparat må kun åbnes af fagfolk. Hvis dækslet tages af, udsættes man for livsfarlig højspænding.



Denne mærkat på komponenten advarer om uisoleret, fartig spænding i apparatet... høj nok til at give elektrisk stød.



Denne mærkat på komponenten advarer om vigtig drifts- og vedligeholdelsesinformation I den tilhørende litteratur.

Svenska

Viktiga säkerhetsföreskrifter

Spara dessa föreskrifter för framtida bruk.

Följ alla anvisningar och Varningar som anges på enheten.

Använd alltid rätt nätspänning. Se tillverkarens bruksanvisningar för information om effektkrav. Märkväl, art andra matningsspänningar eventuellt kräver att en annan typs nätsladd och/eiler kontakt används.

Installera inte enheten i ett oventilerat stativ, eller direkt ovanför utrustningar som avger värme, t ex effektförstärkare. Se till att omgivningens temperatur vid drift inte överskrider det angivna värdet i produktspecifikationen.

Behållaren är försedd med hål och öppningar för ventilering. För att garantera tillförlitlig funktion och förhindra överhettning får dessa öppningar inte blockeras eller täckas. Inga föremål får skuffas in genom ventilationshalen. Inga vaskor får spillas på enheten.

Anslut aldrig audioeffektförstärkarutgångar direkt till någon av enhetens kontakter.

För att undvika elstöt eller brandfara får enheten inte utsättas för regn eller fukt, eller användas på ställen där den blir våt.

Använd inte enheten om den har fallit i golvet, skadats, blivit våt, eller om dess prestanda förändrats märkbart, vilket kräver service.

Enheten får öppnas endast av behörig servicepersonal. Farliga spänningar blir tillgängliga när locken tas bort.



Denna triangel, som visas på din komponent, varnar dig om en isolerad fartig spänning inne i enheten. Den höga spänningen är eventuellt så hög att fara för elstöt föreligger.



Denna triangel, som visas på din komponent, anger att viktiga bruksanvisningar och serviceanvisningar ingår i dokumentationen fråga.

Norsk

Viktig Informasjon om sikkerhet

Ta vare på denne veiledningen for senere bruk.

Følg alle anvisningene og advarslene som er angitt på apparatet. Apparatet skal alltid anvendes med korrekt spenning. Produktbeskrivelsen inneholder spesifikasjoner for strømkrav. Vær oppmerksom på at det ved ulike driftsspenninger kan være nødvendig å bruke en annen ledning- og/ eller stopseltype.

Apparatet skal ikke monteres i skap uten ventilasjon, eller direkte over varmeproduserende utstyr, som for eksempel kraftforsterkere. Den maksimale romtemperaturen som står oppgitt i produktbeskrivelsen, skal overholdes.

Apparatet er utstyrt med ventilasjonsåpninger. For at apparatet skal være pålitelig i bruk og ikke overopphetes, må disse åpningene ikke blokkeres eller tildekkes. Stikk aldri noe inn i ventilasjonsåpningene, og pass på at det aldri søles noen form for væske apparatet.

Utgangsplugg fra audioforsterkere skal aldri koples direkte til apparatet.

Unngå brannfare og elektrisk stat ved å sørge for at apparatet ikke utsettes for regn eller fuktighet og ikke anvendes i nærheten av vann. Apparatet skal ikke brukes hvis det har blitt utsatt for støt, er skadet eller blitt vått, eller hvis endringer i ytelsen tyder på at det trenger service. Dette apparatet skal kun åpnes av fagfolk. Hvis dekslet fjernes, utsettes man for livsfarlig høyspenning.



Komponenten er merket med denne trekanten, som er en advarsel om at det finnes uisolert, farlig spenning inne i kabinettet... høy nok til å utgjøre en fare for elektrisk støt.



Komponenten er merket med denne trekanten, som betyr at den tilhørende litteraturen inneholder viktige opplysninger om drift og vedlikehold.

Suomi

Tärkeitä turvallisuusohjeita

Säilytä nämä ohjeet tulevaa käyttöä varten.
Seuraa kaikkia yksikköön merkittyjä ohjeita ja varoituksia.

Käytä aina oikeaa verkkojännitettä. Tehovaatimukset selviävät valmistajan käyttöohjeista. Huomaa, että en käyttäjännitteet saattavat vaatia toisenlaisen verkkojohdon ja/tai -pistokkeen käytön.

Älä asenna yksikköä telineeseen jossa ei ole tuuletusta. tai välittömästi lämpöä tuottavien laitteiden, esim. tehovahvistimien, yläpuolelle. Ympäristön lämpötila käytössä ei saa yittää tuotespesifikaation maksimilämpötilaa.

Kotelo on varustettu tuufetusreiillä ja -aukoilla. Luotettavan toiminnan vaimistamiseksi ja yllälämpenemisen välttämiseksi näitä aukkoja ei saa sulkea tai peittää. Mitään esineitä ei saa työntää tuuletusaukkoihin. Mitään nesteitä ei saa kaataa yksikköön.

Älä kytke audiotehovahvistimen lähtöjä suoraan mihinkään yksikön liittimeen.

Sähköiskun ja palovaaran välttämiseksi yksikkö ei saa olla sateessa tai kosteassa, eikä sitä saa käyttää märässä ympäristössä.

Älä käytä yksikköä jos se on pudonnut, vaurioitunut, kostunut, tai jos sen suorituskyky on huomattavasti muuttunut, mikä vaatii huoltoa.

Yksikön saa avata vain laitteeseen perehtynyt huoitohenkilö. Kansien poisto altistaa sinut vaarallisille jännitteille.



Tämä kolmio, joka esiintyy komponentissasi, varoittaa sinua eristämättömän vaarallisen jännitteen esiintymisestä yksikön sisällä. Tämä jännite saattaa olla riittävän korkea aiheuttamaan sähköiskuvaaran.



Tämä kolmio, joka esiintyy komponentissasi, kertoo sinulle, että tässä tuotedokumentoinnissa esiintyy tärkeitä käyttö- ja ylläpitoohjeita.

Introduction

Congratulations on your purchase of this precision component and thank you for your selection of Parasound. Your new AVC-1800 Audio Video Controller is designed to be the heart of your home theater system and to provide you with years of listening and viewing enjoyment.

Surround modes include Dolby Digital, Dolby Pro Logic, DTS, and two channel stereo. You can set up your AVC-1800 to detect the type of signal present at each input and automatically decode it based on how the source software was originally encoded. Your AVC-1800 also has discrete 5.1 channel analog inputs to accommodate the possibility of future formats.

The AVC-1800 has audio connections for independent remote zone operation. This feature allows you to route any of the analog audio sources connected to the AVC-1800 to both the main zone (*Main*) and a separate remote zone (*Zone*).

If you are in a hurry to have your AVC-1800 up and running and if you are already comfortable with installing audio/video systems, refer to the drawings and descriptions on pages 10-16. However, since the AVC-1800 has extensive control capabilities, we strongly advise you take the time to read these instructions thoroughly. You will need them to fully understand and appreciate its extensive capabilities.

About this Manual

The names of connectors and controls are italicized to help you find what you are looking for within in a particular section. On-screen and front panel display indications are in small capital letters. This manual was also written with the assumption that you have some prior experience hooking up and installing audio/video systems.

Unpacking and Inspection

Carefully unpack your AVC-1800 Audio Video Controller and locate the enclosed accessories:

- AVC-1800 Owner's Manual
- Warranty Card (North America only. Warranties in other regions provided by the respective authorized Parasound Distributor)
- Universal remote control with 4 AAA batteries
- Detachable AC cord
- FM Folded Dipole 300 Ω Antenna
- FM 300 ohm to 75 Ω balun matching transformer
- Threaded DIN to F type 75 Ω coax FM antenna adapter
- AM loop antenna

Be sure to carefully inspect the AVC-1800 for any signs of shipping damage. If you believe you notice any, contact your Parasound Dealer immediately. Be sure to save both cartons and the packing inserts for future transport and always pack the smaller carton into a larger protective outer carton before shipment.

Placement of Your AVC-1800

Install your AVC-1800 near your source equipment so you can use the shortest possible interconnect cables. Keep your AVC-1800 out of direct sunlight because it could interfere with the remote control sensor. You should also keep the unit away from heat sources such as hot air ducts radiators and moisture sources such as open windows.

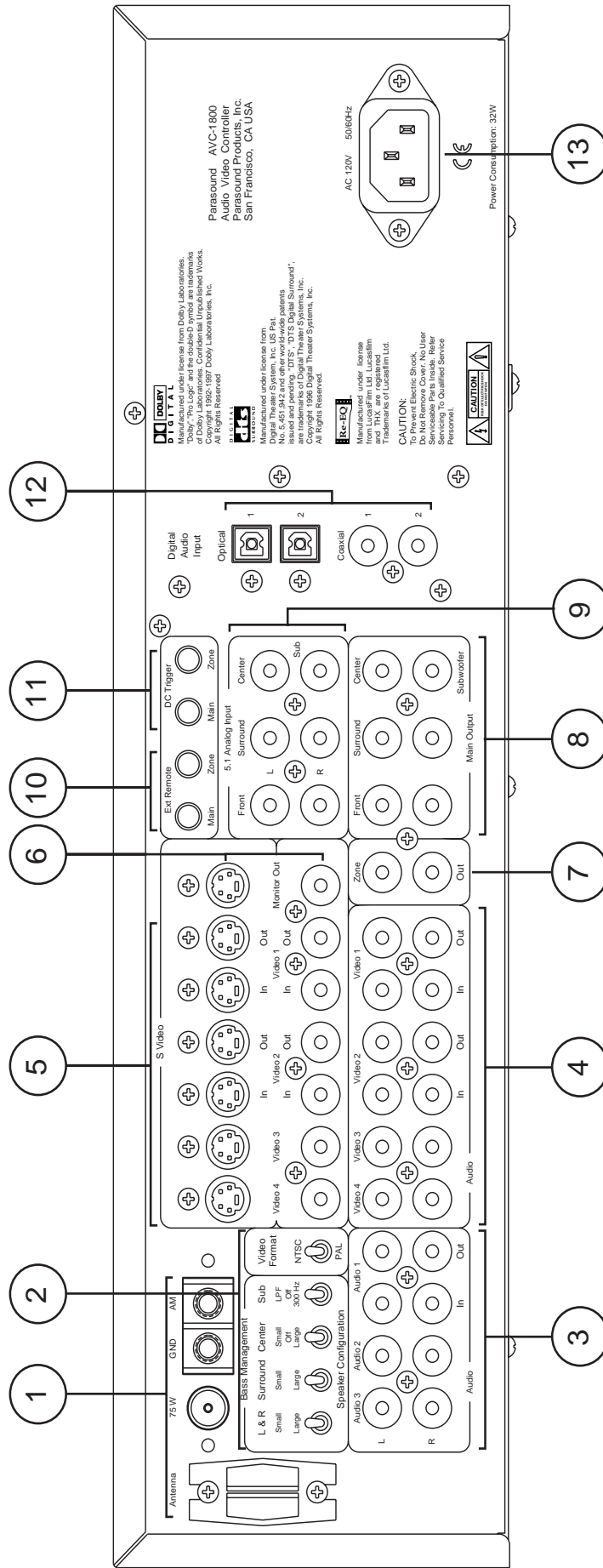

Rear Panel Connections

1. Antenna Input Connections and AM Antenna Clamp

Connect your antennas to these inputs. Antennas are provided, but you can use other antennas for improved reception. The provided AM antenna snaps into the AM antenna clamp.

2. Bass Management and Video Format Switches

These switches allow you to configure the bass management circuitry to match your speaker system. The video format switch selects NTSC or PAL formats for proper video synchronization.

3. Audio-Only 1-3 Analog Inputs and Audio Record Output

All three analog *Audio*-only inputs are compatible with typical analog line level sources. Connect the left and right analog audio output of your audio source components to any of these audio-only inputs. Note that *Audio 1* has a set of *Record Out* jacks. Connect the left and right *Record* output jacks of the AVC-1800 to the *Record/Input* jack of your analog recording component.

4. Audio/Video 1-4 Analog Inputs and Audio/Video 1-2 Video Record Output Jacks

All four audio/video analog inputs are compatible with typical analog line level sources. Connect the left and right analog audio output of your audio/video source components to these *In* jacks. Video 1 and 2 also have a set of analog audio *Record Out* jacks. Connect these outputs of the AVC-1800 to the *Record/Input* jacks of your analog recording component. Video 1 and 2 also have a set of video *Record* Output jacks. Connect these outputs of the AVC-1800 to the Video *Record/Input* jack of your recording component such as a VCR.

5. Composite and S-Video Inputs

Each of the four *Audio/Video Inputs* has both composite and S-video connectors with separate video circuits and amplifiers. The AVC-1800 cannot convert video signals from S-Video to composite video, or vice versa. For example, when you connect a video signal to one of the four RCA composite RCA input jacks, the video signal will only be available through the RCA composite *Monitor* and *Record* output jacks.

6. Video Monitor Outputs

There are both composite and S-Video output connections on the AVC-1800. Connect the Composite and/or S-Video *Monitor Out* connectors to the corresponding input connector of your monitor or projector.

7. Zone Outputs

The *Zone* audio output connections provide independent remote zone operation. Connect the left and right *Zone* audio output to your remote zone amplifier or system controller.

8. Main Outputs

The AVC-1800 provides stereo output pairs for the left and right front and surround speakers, a monaural output for the center speaker, and a monaural output for the subwoofer. Connect these outputs to the inputs of your power amplifiers.

9. 5.1 Analog Inputs

The *5.1 Analog Input* connections accept six channels of processed analog output from a DVD audio player. Connect the six discrete outputs of your source component to the corresponding *5.1 Analog* inputs of the AVC-1800. You can also use the left and right channel of the *5.1* analog inputs for an additional two channel analog source.

10. Infrared Inputs

The *Main* and *Zone* external infrared inputs accommodate infrared remote control operation from the main and remote zones. Connect the output of separate compatible infrared repeater systems to these inputs.

11. DC Triggers

These *DC Trigger* outputs provide a +12 Volt DC trigger to activate equipment such as power amplifiers or relays in each zone. Connect these outputs to the DC trigger input of the component you want to activate.

12. Digital Inputs

Your AVC-1800 has four digital inputs: two fiber-optic Toslink inputs and two 75 Ω Coaxial inputs. Connect the digital outputs of your source equipment to these inputs.

13. AC Line Cord Connection

The rear panel mounted IEC standard AC receptacle accepts the AC cord supplied with your AVC-1800. Plug the female end of the AC cord firmly into the rear mounted AC receptacle and make sure that it is properly seated, then connect the male end to an uninterrupted AC power line.

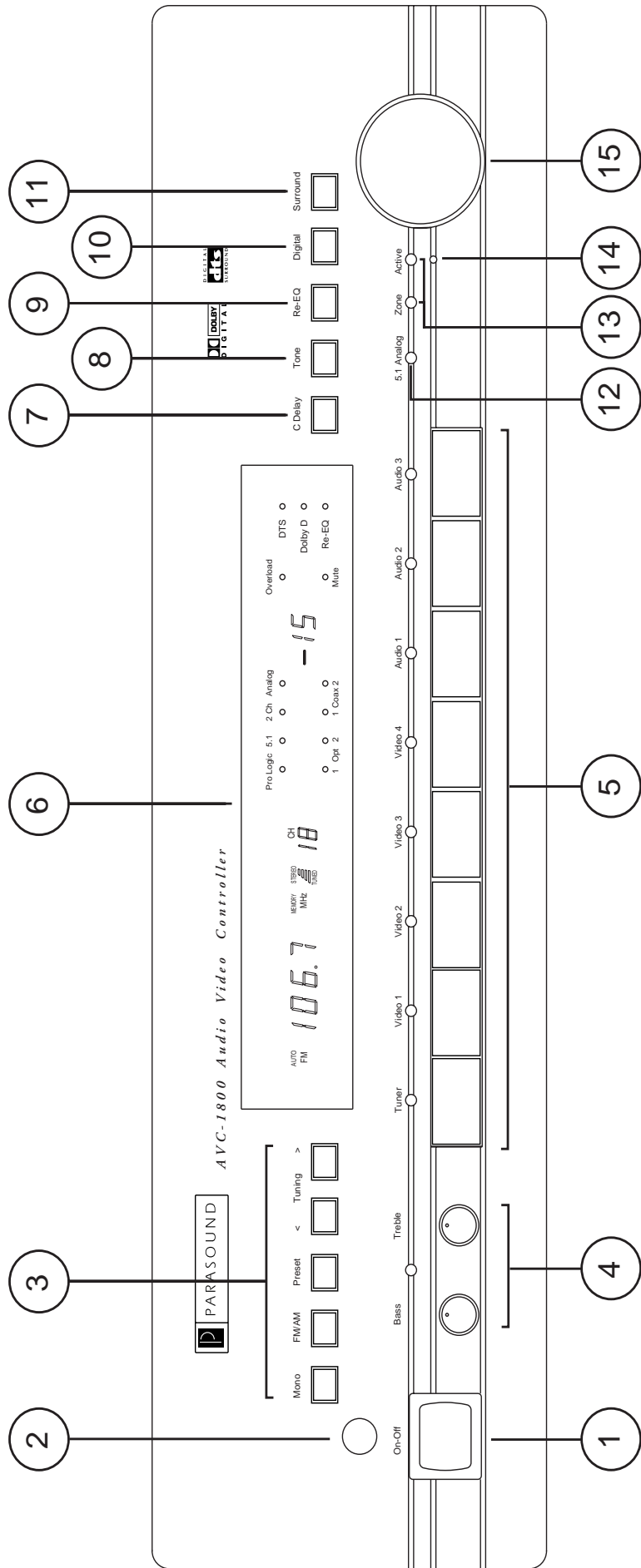

Front Panel Controls

1. On-Off Button

Press the On-Off button to turn the AVC-1800 on and off. When you first turn the unit on, the front panel displays show the last selected source input, digital input, surround mode, and master volume level. The tuner frequency and station preset numbers are also displayed.

2. Infrared Receiver

Infrared signals from the remote control are received through the IR receiving eye for the main zone.

3. Tuner Control Buttons

Mono

Press the Mono button to receive weaker stations and reduce interchannel noise.

FM/AM

This button allows you to select FM and AM frequency bands.

Preset

The preset button scrolls through all 29 preset stations that you may store into memory one at a time. Preset numbers without active broadcast frequencies are skipped when the preset button is pressed.

Tune ◀ ▶ Buttons

While in the Auto tuning mode, pressing this button normally advances to the next active broadcast frequency. In the manual tuning mode, these buttons select FM frequencies in 100 kHz steps (50 kHz steps for export units) and AM frequencies in 10 kHz steps (9 kHz for export units)

2 Ch Indicator

This indicator illuminates when the AVC-1800 has been set to two-channel operation or it detects a Dolby Digital 2/0 signal. Incoming 5.1 signals are downmixed to two channels when this is on.

Volume Level

This indicator displays the master level of the AVC-1800 from -60 dB to +10 dB.

Analog Overload Indicator

This red indicator will illuminate when the internal A to D converters are overloaded. This can only occur while an analog source is overloading the input.

Mute Indicator

This indicator lights when the *Mute* button is engaged from the remote control. This LED also lights when the remote zone is on while the main zone is off.

Digital and Analog Input Indicators

These LEDs light when the corresponding digital (Optical 1-2, Coax 1-2) or Analog input is selected with the *Digital* button.

DTS indicator

This indicator illuminates when the AVC-1800 has detected a DTS bitstream.

Dolby Digital

The Dolby Digital indicator illuminates when the AVC-1800 has detected a Dolby Digital bitstream.

7. Center Delay Button

Press this button to select delay time for the center channel speaker. Each press of this button increases delay from one mS to a maximum of five mS.

8. Tone Button

This button activates the bass and treble controls. The TONE indicator illuminates when the tone controls are active.

9. Re-EQ Button

Press the *Re-EQ* button to engage Lucasfilm Re-Equalization. Press it again to turn it off.

10. Digital Button

The *Digital* button selects the four digital inputs or the analog input. When you select a digital input to accompany one of the input sources, the AVC-1800 will recall that digital input the next time you select the input source, thereby linking them together.

11. Surround Button

By pressing the *Surround* button, you can select between 5.1, Pro Logic, and two channel. Selecting the two-channel surround mode will downmix a 5.1 channel signal.

12. 5.1 Analog Indicator

This LED lights when you select the 5.1 analog input.

13. Zone Indicators

When the remote zone is on, the *Active* LED lights. The Zone LED lights for 5 seconds after a remote zone command is issued.

14. Reset Button Access Hole

This button restores all factory defaults and clears the programmed memory. Use a toothpick or small non-metal tool to access the reset button.

15. Volume Control

This control adjusts the master volume up and down in 1 dB increments. The volume display changes to show the current volume level.

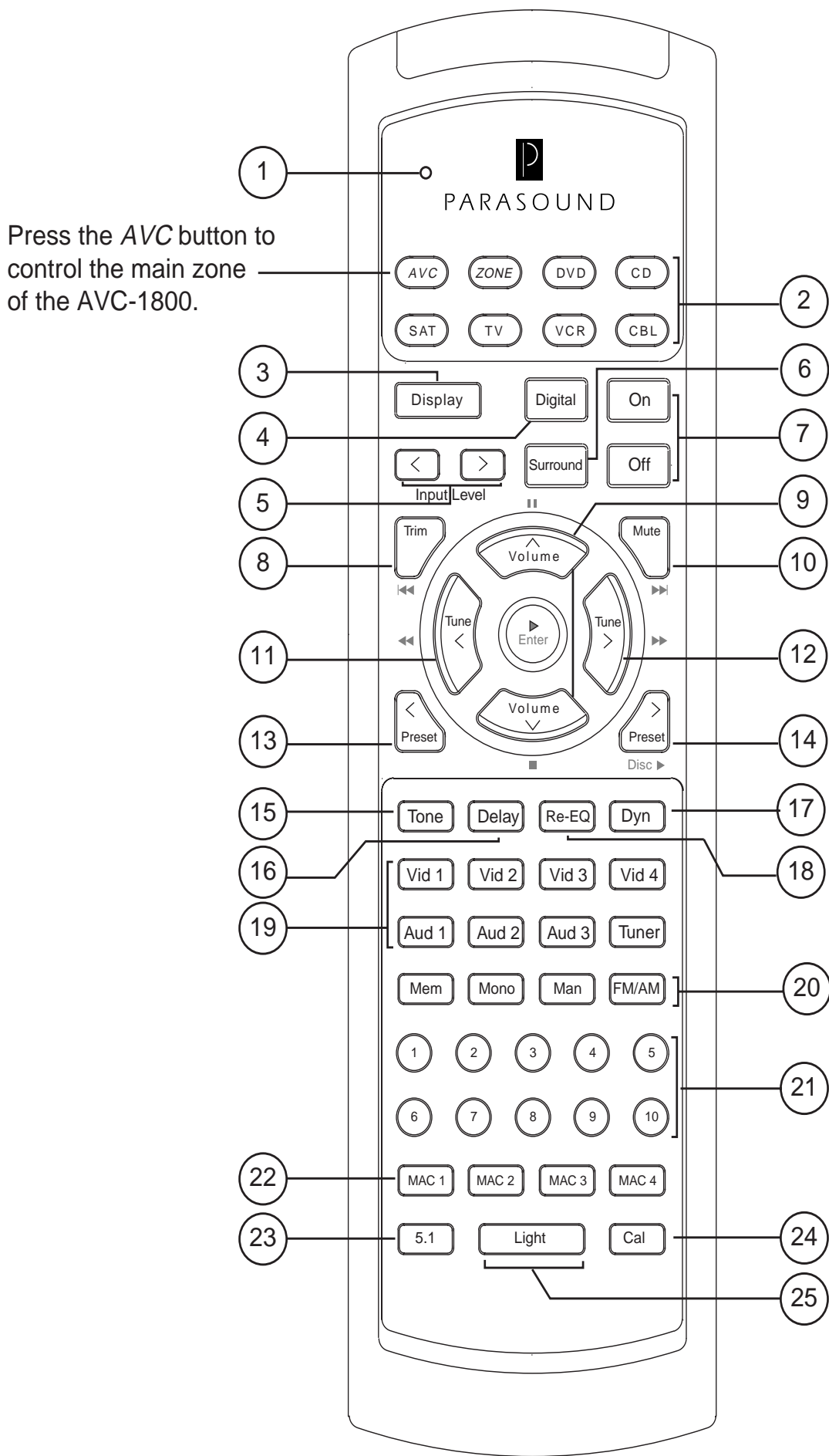

Press the AVC button to control the main zone of the AVC-1800.

The Learning Remote Control Main Zone Control Buttons

1. Programming Status LED

This three-color LED flashes when programming infrared codes into the learning remote control.

2. Eight Device Buttons

The device buttons allow you to choose different “pages” to control up to six additional components. *Note: Press the AVC button first to control the main zone of the AVC-1800 and press the Zone button to operate the remote zone.*

3. Display Button

The *Display* button activates the on-screen display to show the operational status of the AVC-1800.

4. Digital Button

The *Digital* button allows you to select any of the four digital inputs or the analog input.

5. Input Level Buttons

These buttons adjust the signal level to the analog input circuit to prevent overload and distortion.

6. Surround Button

Press the Surround button to select the Surround Processing modes, including Pro Logic, 5.1, and two channel stereo.

7. On and Off Buttons

Press the *On* button to turn the AVC-1800 on; press the *Off* button to turn it off this function is differein for remote zone operation. See page 16.

8. Trim Button

Press and release the *Trim* button to temporarily trim channel levels to suit your taste while watching a film or listening to a recording.

9. Volume Button

The *Volume* Δ and ∇ buttons adjust the master volume up and down in 1 dB steps. These buttons are also used for making adjustments during trim and calibration operations.

10. Mute Button

Press the *Mute* button to interrupt the audio signal from reaching the Main analog output jacks of the AVC-1800.

11. Tune \triangleleft Button

When the tuner is active, pressing the *Tune* \triangleleft button selects the previous available broadcast frequency.

12. Tune \triangleright Button

When the tuner is active, pressing the *Tune* \triangleright button selects the next available broadcast frequency.

13. Preset \triangleleft Button

When the tuner is active, each press of the *Preset* \triangleleft button selects the previous preset station.

14. Preset \triangleright Button

When the tuner is active, each press of the *Preset* \triangleright button selects the next preset station.

15. Tone Button

This button activates the bass and treble controls. The tone controls are only available in the 2 channel mode.

16. Delay Button

Press this button to select the amount of delay time for the rear surround speakers.

17. Dynamic Range Control Button

The *Dyn* button engages a fixed degree of Dynamic Range Control if there was any included in the bitstream during the encoding process.

18. Re-EQ Button

Press the *Re-EQ* button to engage Lucasfilm Re-Equalization for any of the Surround modes.

19. Direct Access Source Buttons

These buttons provide direct access to each of the seven inputs plus the tuner.

20. Tuner Functions

These buttons control the tuner functions of the AVC-1800 including Memory, Mono, Manual Tuning, and AM/FM band selection.

21. Numerical Preset Buttons 1-10, 11-20, 21-29

Pressing any of these numerical preset buttons allows you to select the radio station previously memorized between 1 and 10. To access preset numbers above 10, press the numerical button again to add 10 to that preset number. For example, pressing 5 twice accesses preset 15 and pressing three times accesses preset 25.

22. Macro Buttons

The four macro buttons allow you to program a series of commands for one touch operation of multiple functions of different components such as turning on the AVC-1800 and your DVD player and selecting play.

23. 5.1 Button

This button instructs the AVC-1800 to receive signals from the 5.1 Analog Input jacks. It does not select 5.1 digital surround decoding.

24. Light Button

The *Light* button illuminates all the remote control buttons for approximately 5 seconds.

25. Cal Button

Press the *Cal* button to activate the calibration circuitry that allows you to set the output levels of each channel of the AVC-1800.

The Learning Remote Control Remote Zone Control

1. Programming Status LED

This three-color LED flashes when programming infrared codes into the learning remote control.

2. Device Buttons

The device buttons allow you to choose different “pages” to control up to six additional components. *Note: Press the AVC button first to control the main zone of the AVC-1800 and press the Zone button to operate the remote zone.*

3. On-Off Button

Press the *On* button to turn the AVC-1800 on for the remote zone; press the *On* button again to turn it off. This operation is different for the main zone.

4. Volume Buttons

The *Volume* Δ and ∇ buttons adjust the master volume up and down in 1 dB steps.

5. Mute Button

Press the *Mute* button to interrupt the audio signal from reaching the zone output jacks of the AVC-1800.

6. Tune \triangleleft Button

When the tuner is activated, pressing the *Tune* \triangleleft button selects the previous available broadcast frequency.

7. Tune \triangleright Button

When the tuner is active, each press of the *Preset* \triangleright button selects the previous preset station.

8. Preset \triangleleft Button

When the tuner is active, each press of the *Preset* \triangleleft button selects the previous preset station.

9. Preset \triangleright Button

When the tuner is active, each press of the *Preset* \triangleright button selects the next preset station.

10. Direct Access Source Buttons

These buttons provide direct access to each of the seven inputs and the tuner.

11. Tuner Functions

These buttons control the tuner functions of the AVC-1800 including Memory, Mono, Manual Tuning, and AM/FM band selection.

12. Numerical Preset Buttons 1-10, 11-20, 21-29

Pressing any of these numerical preset buttons allows you to select the radio station previously memorized between 1 and 10. To access preset numbers above 10, press the numerical button again to add 10 to that preset number. For example, pressing 5 twice accesses preset 15 and three times accesses preset 25.

13. Macro Buttons

The four macro buttons allow you to program a series of commands for one touch operation of multiple functions of different components such as turning on the AVC-1800 and your DVD player and selecting play.

14. Light Button

The *Light* button illuminates all the remote control buttons for approximately 5 seconds.

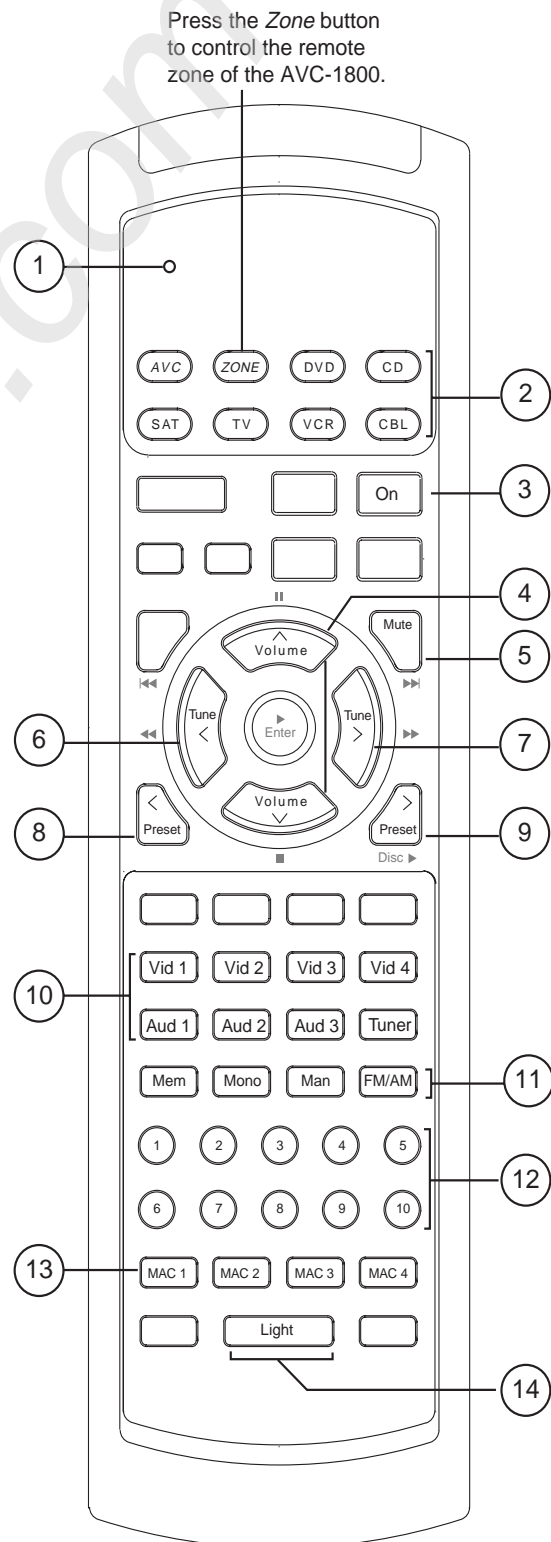

Optional Rack Mounting Kit

If you want to rack mount your AVC-1800, you will need to obtain the optional Parasound RMK-3 Rack Mount Kit. When you install the RMK-3 onto the AVC-1800 and remove its four feet, the rack mounting brackets will occupy three rack spaces (5 1/4 inches high) in a standard 19" wide equipment rack. There will be slightly less than 3/4" gap above the front panel when mounted in this fashion. Refer to the RMK-3 instructions for installation procedures. Make certain to use the eight insulated shoulder washers included with the RMK-3 to prevent metal-to-metal contact between its brackets and your equipment rack and in order to prevent ground loops that could cause audible hum.

Making Connections to Your AVC-1800

Before making any connections to your AVC-1800, be sure to turn off the power to your amplifiers. When connecting cables to the AVC-1800, make sure there is no strain or tension on any connections that could cause them to pull loose later.

Rear Panel Connections

To make installing the AVC-1800 and our instructions easier, we have organized discussion about connections in a clockwise direction from the left side to the right side of the rear panel and also by functional groups for analog audio, video, digital audio, antenna, infrared control interface, and AC cord. References to specific connectors on the AVC-1800 are usually italicized.

Antenna Connections

You will not be able to receive any radio stations unless antennas for FM and AM bands are connected. Following are options to connect FM and AM antennas to your AVC-1800.

FM Dipole Antenna

A standard FM "folded dipole" 300 ohm wire antenna with is included with your AVC-1800. This dipole antenna is adequate for most urban and suburban locations. Connect the spade lugs of the dipole antenna to the two screw terminals on the included small "balun" matching transformer. Carefully press the balun over the 75 Ω female connector of the rear panel of your AVC-1800. Next, spread out the antenna and hang on the wall or the back of the equipment cabinet. Experiment with the direction and placement of the dipole antenna to obtain the best reception.

75 Ohm Coaxial Antenna

The AVC-1800 has a standard DIN-type 75 Ω connector for a push-on coaxial FM antenna plugs. An adapter is included to accommodate the threaded F-type connectors that are used in North America.

Outdoor Roof Antenna

For best reception and maximum noise rejection, we recommend the use of a high-quality outdoor FM antenna. The additional stations you can receive and the superior sound quality will make the extra effort worthwhile. Connect the outdoor antenna with a 75 Ω coaxial cable directly to the *75 Ω FM Antenna Input* of the AVC-1800. If you use 300 Ω twin lead, connect the two bare wire leads to the included "balun" adapter and press it onto the 75 Ω coaxial FM antenna input connector.

Cable TV and Community Antenna

In many situations, you may be able to use the FM antenna output of a cable TV or a community antenna jack. These connect in the same fashion as an outdoor antenna.

AM Antenna and Clamp

A molded plastic loop antenna is supplied with your AVC-1800. Connect the two wires of the AM loop antenna to the posts labeled *AM* and *GND*. Position the loop antenna for best AM reception. If you are trying to pick up very distant stations, you may connect a single long wire to the *AM* terminal and a good earth ground to the *GND* terminal. Once you have connect the AM antenna, fasten it to the antenna clamp on the rear panel.

Bass Management Switches

Bass management is designed to assure overall balanced response by accommodating many different types of speaker systems that may or may not be able to reproduce frequencies below 80 Hz. The *Bass Management* switches allow you to configure your speakers to reproduce low frequencies below 80 Hz, or to filter out these frequencies and route them to your front speakers or only to your subwoofer channels. The AVC-1800 has four toggle switches, which you must set according to the characteristics of your speakers. Refer to the setup section of this manual for more details on setting the bass management switches to accommodate your home theater system.

NTSC/PAL Switch

This switch allows you to select the display default system to be for the NTSC or PAL video format. PAL is the video format in most European countries and NTSC is the predominant video format in other regions. If you select the incorrect format, the on-screen display will not synchronize properly with your television and will look scrambled.

Input Connections

Analog Audio 1-3 Input Connections

The three audio-only analog inputs are compatible with typical analog line level sources such as CD players, MiniDisc players, cassette decks, etc. Connect the left and right analog audio outputs of your audio source components to these inputs. You can also “assign” any of the four *Digital* audio inputs to accompany any of these three *Audio* analog inputs.

Audio Only Record Output Connections

The audio signal from the source you select for the main zone is routed to the *Record Output* connectors of *Audio 1*. Connect the left and right play/output of your tape deck to the left and right *Audio 1* input connectors. Next, connect the left and right *Record Output* connectors of your AVC-1800 to the left and right audio record/input connectors of your tape deck.

Analog Audio/Video 1-4 Input Connections

All four Audio/Video analog inputs are compatible with typical line level sources such as DVD players, videocassette recorders, satellite receivers, cable converter boxes, etc. Each of the four Audio/Video inputs also switches an accompanying NTSC/PAL composite video and an S-Video input. You can also assign any of the four Digital audio inputs to accompany these four Audio/Video inputs. If you have a DVD player, be sure to connect its digital output to one of the digital inputs of the AVC-1800 for digital surround decoding.

S-Video and Composite Video Input Connections

Each of the four Audio/Video inputs has both composite and S-Video connectors with separate video circuits and amplifiers. The AVC-1800 cannot convert video signals from S-video to composite video, or vice versa. For example, when you connect a video signal to one of the four RCA composite RCA input jacks, the proper video signal will only be available through the RCA composite *Monitor* and *Record* output jacks. If you try to cross video platforms, the signal will be black and white and distorted.

Record and Playback Connections for Video 1 and Video 2

Video inputs 1 and 2 have audio and video record inputs so you can connect up to two audio/video recording components such as a video cassette recorder.

For audio, connect the left and right audio output connectors from the VCR you'll use for recording to the corresponding left and right audio inputs of either Video 1 or Video 2 labeled *In*. Next, connect the left and right *Out* connectors of the AVC-1800 to the left and right audio input connectors of the VCR.

For video, connect the composite and/or S-Video output connectors from the VCR you will use for recording to the *Video 1* or *2 In* connectors of the AVC-1800. Next, connect the corresponding *Video Out* connectors of the AVC-1800 to the composite and or S-Video input connector of the VCR.

Zone Audio Output Connections

The AVC-1800 has analog stereo connections for independent remote zone operation. This feature allows you to route any of the analog input sources connected to the AVC-1800 to both the main zone (*Main*) and a separate remote zone (*Zone*). You can listen to different or the same sources in the main and remote zones simultaneously. Connect the left and right *Zone Audio Outputs* to your remote zone power amplifier or system controller.

Composite and S-Video Monitor Output Connections

If your video monitor or projector is equipped with separate input connections and switching for composite video and S-Video, you can connect either or both video formats to the AVC-1800's corresponding *Composite Video* or *S-Video* connectors. Note that the AVC-1800 does not convert S-Video input signals to composite video output signals or composite video to S-Video or vice versa.

Main External Remote Control

The *Main External Remote* allows for infrared remote control operation via a wired infrared repeater system or system controller when infrared commands cannot directly reach the front panel infrared receiver. The input connector accepts a standard 1/8-inch (3.5 mm) two conductor mini plug. The tip is positive and the sleeve is negative. Your Authorized Parasound Dealer or Custom Installer can recommend a compatible infrared repeater system for the AVC-1800. Connect the output of an infrared repeater system to the *Main IR* input.

Zone External Remote Control

The *Zone External IR* allows for independent control of the AVC-1800 when routing audio to a remote zone. The input connector accepts a standard 1/8-inch (3.5 mm) two conductor mini plug. The tip is positive and the sleeve is negative. Your Authorized Parasound Dealer or Custom Installer can recommend a compatible infrared repeater system for the AVC-1800. Connect the output of an infrared repeater system to the *Zone IR* input.

Main DC Trigger

This jack provides a +12 Volt DC trigger voltage to activate equipment that can be triggered with DC voltage such as power amplifiers, relays, motorized projection screen, fans, lights, or other components. Connect the *Main DC Trigger* output of the AVC-1800 to the DC input of the component you want to activate. The DC trigger delivers up to up to 200 milliamps of current. The *Main DC Trigger* accepts a sub-mini (2.5 mm) two-conductor mini plug. The tip is positive and the sleeve is negative. You can program the AVC-1800 to activate the *Main DC Trigger* in response to turning on the AVC-1800 or to a button stroke on its remote control. Refer to the Setup section for details on programming the *Main DC Trigger*.

Zone DC Trigger

This jack provides a +12 Volt DC trigger voltage to activate equipment that can be triggered with DC voltage such as power amplifiers or relays. Connect the *Zone DC Trigger* output of the AVC-1800 to the DC input of the component you want to activate. The DC trigger delivers up to up to 200 milliamps of current. The *Zone DC Trigger* accepts a sub-mini (2.5 mm) two-conductor mini plug. The tip is positive and the sleeve is negative. You can program the AVC-1800 to activate the *Zone DC Trigger* in response to turning on the AVC-1800 from a remote zone, or to a button stroke on its remote control. Refer to the Setup section for details on programming the *Zone DC Trigger*.

5.1 Analog Inputs

The *5.1 Analog Input* jacks are designed to accept up to six channels of processed analog output from a component with discrete channels such as a DVD Audio or Super Audio CD player. With this advanced feature, the AVC-1800 will be able to accept future sources whose technology we cannot anticipate today. Connect the six discrete outputs of your source component to the corresponding *5.1 Analog Input* jacks of the AVC-1800. The master volume control adjusts the level for the 5.1 analog inputs.

Main Output Connections

Front Left and Right Channel Outputs

Connect the *Left* and *Right Front* channel outputs of your AVC-1800 to two channels of a multi-channel amplifier that are connected to your main front left and right (L, R) speakers.

Center Channel Output

Connect the *Center* channel output of your AVC-1800 to an input of a multi-channel amplifier that is connected to your center (C) speaker.

Left and Right Surround Channel Outputs

Connect the *Left* and *Right Surround* output jacks of your AVC-1800 to two channels of the multi-channel amplifier that are connected to your left and right surround (LS, RS) speakers.

Subwoofer Output Connection

When using a powered subwoofer with a built-in amplifier, connect the *Subwoofer* output of your AVC-1800 to the line input of your subwoofer. Make sure you switch off the crossover on your subwoofer amp, because the 24 dB per octave low pass filter of the AVC-1800 should be superior to it. If your sub does not have a bypass switch for its crossover, adjust it to its highest frequency to minimize “double filtering.”

Digital Audio Input Connections

Your AVC-1800 has four digital input connections: two *Optical* Toslink and two *Coaxial* RCA connectors. You may use the digital output of a source component in conjunction with its own analog output or that of another source component. Once you have connected the digital output of your source component to one of the *Digital Audio Inputs* of the AVC-1800, you can choose a Digital input to be selected simultaneously with any of the four *Audio/Video* or the three *Audio-only* sources. Refer to the setup instructions for *Digital Audio Input* assignment procedures. For best results, use only cables intended for digital signal transmission.

Optical Toslink Input Connections

Each of the two optical Toslink inputs on the AVC-1800 labeled *Optical 1* and *2* accept a standard S/PDIF digital bitstream from any CD player, DVD player, laserdisc player, DSS receiver, or other digital component equipped with a Toslink optical output. Connect the optical output of your digital source to either of the optical inputs using a Toslink cable.

Coaxial Digital Inputs

The two coaxial digital inputs on the AVC-1800 labeled *Coaxial 1* and *2* accept a standard S/PDIF digital bitstream from any CD player, DVD player, DSS receiver, or other digital component equipped with a 75 Ω coaxial output. Connect the coaxial output of your digital source to either of the coaxial inputs using a digital interconnect cable designed for this application.

AC Line Cord Connection

The rear panel mounted IEC standard AC receptacle accepts the AC cord supplied with your AVC-1800. We recommend the use of an AC line filter to protect the AVC-1800 against line surges and voltage fluctuations. Plug the female end of the AC cord firmly into the rear mounted AC receptacle and make sure that it is properly seated, then connect the male end to an uninterrupted AC power line.

AVC-1800 Front Panel Controls

We designed the AVC-1800 user interface to be simple and intuitive, so we avoided unnecessary front panel controls and indicators that tend to make operation confusing. During setup, you will have the opportunity to program typical functions and operations into memory for easy control of your AVC-1800.

On-Off Button

Press the *On-Off* button to turn the unit on and off. When you turn on the AVC-1800, its front panel display will show you the status of the settings that were made before the unit was last turned off. The items displayed are the Input Source, Digital Input, Surround Mode, and Volume Level. The tuner frequency and preset number are also displayed regardless of whether the tuner is active.

Tuner Control Buttons

***Mono* Button**

Press the *Mono* button to receive weaker stations and reduce interchannel noise.

***FM/AM* Button**

This button allows you to select FM or AM frequency bands.

***Preset* Button**

The preset button scrolls through all 29 preset stations that were stored into memory one at a time. Preset numbers without active broadcast frequencies are skipped when the preset button is pressed.

Tune* ◀ ▶ *Buttons

While in the Auto tuning mode, pressing this button normally advances to the next active broadcast frequency. In the manual tuning mode, these buttons select FM frequencies in 100 kHz steps (50 kHz steps for export units) and AM frequencies in 10 kHz steps (9 kHz for export units).

Tone Controls and Indicator

The *Bass* control boosts and cuts low frequencies +/- 10 dB. The *Treble* control boosts and cuts high frequencies +/- 10 dB. The *Tone* indicator illuminates when the tone circuitry is activated with the *Tone* button. **The *Bass* and *Treble* controls only affect the left and right channels in the 2 channel mode.**

Input Selection Buttons

Press these buttons to select the Tuner, Audio/Video inputs 1-4, or Audio 1-3 inputs.

Front Panel Display

Tuner Display

The tuner display indicates the current status of the built-in tuner. These indications include the FM or AM band, frequency, auto or manual tuning, signal strength and selected preset. This display remains on even if the tuner is not selected so you know what station will be on when you select the tuner.

Surround Mode Indicators

These indicators let you know the type of digital bitstream the AVC-1800 has detected and how the signal is being processed.

Pro Logic Indicator

This indicator illuminates when you select Pro Logic for an analog, PCM, or Dolby Digital 2/0 signals.

5.1 Indicator

This indicator illuminates whenever the AVC-1800 has detected a digital 5.1 channel encoded signal.

2 Ch Indicator

This indicator illuminates when the AVC-1800 has been set to two-channel operation or it detects a Dolby Digital 2/0 signal. Incoming 5.1 signals are downmixed to two channels when this is on.

Volume Level

This indicator displays the master level of the AVC-1800 from -60 dB to + 10 dB.

Analog Overload Indicator

This red indicator will illuminate when the internal A to D converters are overloaded. This can only occur while an analog source is overloading the input.

Mute Indicator

This indicator lights when the *Mute* button is engaged from the remote control. This LED also lights when the remote zone is on while the main zone is off.

Digital and Analog Input Indicators

These indicators illuminate when the corresponding digital (Optical 1-2, Coax 1-2) or Analog input is selected with the *Digital* button.

DTS Indicator

This indicator illuminates when the AVC-1800 has detected a DTS bitstream.

Dolby Digital Indicator

The Dolby Digital indicator illuminates when the AVC-1800 has detected a Dolby Digital bitstream.

Center Delay Button

Press this button to select delay time for the center channel speaker. Each press of this button increases delay from one mS to a maximum of five mS.

Tone Button

This button activates the bass and treble controls. The *TONE* indicator illuminates when the tone controls are active.

Re-EQ Button

Press the *Re-EQ* button to engage Lucasfilm Re-Equalization. Press it again to turn it off.

Digital Button

The *Digital* button selects the four digital inputs or the analog input. When you select a digital input to accompany one of the input sources, the AVC-1800 will recall that digital input the next time you select the input source thereby linking them together.

Surround Button

By pressing the *Surround* button, you can select between 5.1, Pro Logic, and two channel. Selecting the two-channel surround mode will downmix a 5.1 channel signal.

5.1 Analog Indicator

This LED lights when you select the 5.1 analog input from the remote control.

Zone Indicators

When the remote zone is on, the *Active* LED lights. The **ZONE** LED lights for 5 seconds after a remote zone command is issued.

Reset Button Access Hole

This button restores all factory defaults and clears the programmed memory. Use a toothpick or other small non-metal tool to access the reset button.

Volume Control

This knob adjusts the master volume up and down in 1 dB increments. The volume display changes to show the current volume level.

AVC 1800 Remote Control Buttons

Device Buttons

The device buttons allow you to choose different “pages” to control up to six additional components. **Note: First press the AVC button to control the AVC-1800 and press the Zone button to operate the remote zone.**

Display

The *Display* button activates the on-screen display to show the operational status of the AVC-1800. There are two levels of on-screen display. The first press of the button shows input status, the second press of the button displays the channel levels and decoding status, and the third press turns the display off.

Input Level ◁ ▷ Buttons

These buttons set the signal level to the analog input circuit to prevent overload. If the overload LED illuminates, you need to turn the input level down. Press the *Input ▷* button to increase the level to the analog input circuitry. Press the *Input ◁* button to decrease the level to the analog circuitry.

Digital Button

The *Digital* button allows you select any of the four digital inputs or the analog input.

Surround Button

The *Surround* button allows you to cycle in either direction to select the Surround Processing modes including Pro Logic, 5.1, and two channel stereo.

On and Off Buttons

Press the *On* button to turn the AVC-1800 on; press the *Off* button to turn it off. Separate on and off commands for ease of use while setting up macros or programming external system controllers. This operation is different for the remote zone.

Trim Button

Press and release the *Trim* button to temporarily trim the volume levels of individual channels levels to suit your taste while listening to a particular film soundtrack or recording.

Volume △ ▽ Buttons

The *Volume △* and *▽* buttons adjust the master volume up and down in 1 dB steps. These buttons are also used for making adjustments during Trim and calibration (Cal) operations.

Mute

Press the *Mute* button to interrupt the audio signal from reaching the Main analog output jacks of the AVC-1800. The *Mute* button does not affect the *Record Output* jacks or the *Zone Output* jacks (unless *Zone* is presently under control).

Tune ◀ ▶ Buttons

While in the Auto tuning mode, pressing this button normally advances to the next active broadcast frequency. In the manual tuning mode, these buttons select FM frequencies in 100 kHz steps (50 kHz steps for export units) and AM frequencies in 10 kHz steps (9 kHz for export units).

Preset ◀ Button

Press the *Preset* ◀ button to select the previous preset station.

Preset ▶ Button

Press the *Preset* ▶ button to select the next preset station.

Tone Button

This button activates the bass and treble controls in the two channel mode. When the tone controls are active, the **TONE** indicator illuminates.

Delay Button

Press this button to select the amount of delay time for the surround speakers. Each press of this button increases surround delay time by 5 milliseconds to a maximum of 15 milliseconds.

Re-EQ Button

Press the *Re-EQ* button to engage and disengage Lucasfilm Re-Equalization for any Surround mode. Re-Eq restores the correct tonal balance of a film soundtrack designed for playback in large movie theaters in a relatively small home theater environment. It is not desirable for normal music playback and should be turned off.

Dynamic Range Control Button

The *Dyn* button engages a fixed degree of Dynamic Range Compression that is available if the DVD you are playing includes it in its Dolby Digital bitstream. This feature allows soundtracks with a wide dynamic range to maintain clear audibility even at low levels.

Direct Access Source Buttons

The source buttons provide direct access to each of the eight inputs of the AVC-1800. The source buttons are labeled *Aud* (Audio) 1-3, *Vid* (Video) 1-4, and *Tuner*.

Tuner Functions

Memory Button

This button stores the selected broadcast frequency into memory. Select the frequency you want to store into preset, press *Mem*, then the desired preset number.

Mono

Press the *Mono* button to receive weaker stations and reduce interchannel noise. Mono only works for the tuner. It does not for work for other inputs.

Manual Button

While in the Auto tuning mode, pressing the *Tuning* ◀ ▶ buttons normally selects the previous or next active broadcast frequency. Press the *Man* button to select the manual tuning mode, then the *Tuning* ◀ ▶ buttons selects FM frequencies in 100 kHz steps (50 kHz steps for export units) and AM frequencies in 10 kHz steps (9 kHz for export units)

FM/AM Button

The *FM/AM* button selects FM and AM frequency bands while the tuner is active.

Numerical Preset Buttons 1-10, 11-21, 21-29

Pressing any of these numerical preset buttons allows you to select the radio station previously memorized between 1 and 10. To access preset numbers above 10, press the numerical button again to add 10 to that preset number. For example, pressing 5 twice accesses preset 15 and three times accesses preset 25.

Macro Buttons

The four *Macro* buttons allow you to program a series of commands for one touch control of different components such as turning on your AVC-1800 and DVD player and selecting play.

5.1 Analog Button

This button instructs the AVC-1800 to receive signals from the *5.1 Analog Input* jacks where the analog output from a DVD player or other component with discrete outputs may be connected.

Light Button

The *Light* button illuminates all the remote control buttons for approximately 5 seconds. The illumination makes it easier to see the buttons in a darkened room.

Cal Button

Press and hold the *Cal* button to activate the calibration circuitry to set the levels of each channel of the AVC-1800. Refer to setup section of this manual for details.

Surround Processing Modes

Digital based audio/video source components transmit their audio signals in either Analog, Pulse Code Modulation (PCM), Dolby Digital, or DTS. Your AVC-1800 automatically detects the type of digital signal present at the chosen digital input. The signal is then decoded based upon the surround processing mode you have selected for the audio/video (1-4) or audio only (1-3) input. Following is how the AVC-1800 decodes the incoming signal:

Mode	Encoded Signal	Decoding Format	Active Channels	On-screen Indication
5.1 Ch	5.1 ch Dolby Digital	5.1 ch Dolby Digital	L, C, R, LS, RS, Sub	Dolby Digital 3/2/.1
	5.1 ch DTS	5.1 ch. DTS	L, C, R, LS, RS, Sub	DTS Digital 3/2/.1
Pro - Logic	2 ch Dolby Digital	Pro Logic surround	L, C, R, Mono Surround, Sub	Digital Pro Logic
	2 ch analog input	Pro Logic surround	L, C, R, Mono Surround, Sub	Analog Pro Logic
2 Ch	5.1 ch Dolby Digital	DD 2 channel downmix	L, R, Sub	Dolby Digital 2 Ch
	2 ch Dolby Digital	DD Stereo	L, R, Sub	Dolby Digital 2 Ch
	DTS	DTS 2 channel downmix	L, R, Sub	DTS 2 Ch
	PCM	2 channel stereo	L, R, Sub	2 Ch
	Analog	2 channel stereo	L, R, Sub	2 Ch

Dolby Digital

Dolby Digital delivers up to six totally separate (discrete) channels of sound, also known as 5.1. Like Dolby Surround Pro Logic, it includes Left, Center and Right channels across the front of the room. The sixth channel, the Low Frequency Effects channel, contains additional bass information to maximize the impact of scenes with special effects such as explosions, crashes, etc. The AVC-1800 LFE channel frequency response is 3 Hz to 120 Hz.

Dolby Digital Encoding Indication

Dolby has established a system to let you know how the original material was encoded. It consists of three numbers separated with forward slashes. The first number represents the front channels, the second number represents the rear channels, and the third number represents the LFE. This encoding information is shown in the on screen display. Following are examples of digital bitstream encoding:

Indication Active channels

3/2/.1 (5.1)	Three discrete channels in the front, two in the rear and LFE
3/1	Three discrete channels in the front, mono rear surrounds, and no LFE
2/1	Two discrete channels in the front, mono rear surrounds, and no LFE
2/0	Two discrete channels in the front and no surrounds or LFE

Pro Logic

If the incoming digital signal is encoded in Dolby Digital Surround Pro Logic, the AVC-1800 automatically selects Pro Logic. However, you should use the Surround key to select Pro Logic, for analog and PCM signals if you want the AVC-1800 to decode a stereo signal into Dolby Surround Pro Logic.

DTS

Like Dolby Digital, DTS Digital Surround is an encode/decode system that delivers two or six channels (5.1) of audio for soundtracks and multi-channel recordings. Digital Theater Surround (DTS) surround formatted DVDs must be played back on DVD players that are equipped with DTS output capability.

Two-channel PCM

Digitally encoded PCM material is found on the digital outputs of compact discs and laser discs. If you the select two channel surround mode, the AVC-1800 plays back two channel stereo with sub (depending on bass management configuration). If you select Pro Logic, the AVC-1800 decodes the PCM signal into Pro Logic. If the material was not encoded in Pro Logic, you may still enjoy the resulting surround sound effects.

Analog Audio

Two-channel analog material is typically found on VCR tapes and the analog outputs of CD Players, DVD players and cassette decks. If you the select two channel surround mode, the AVC-1800 plays back two channel stereo. If you select Pro Logic, the AVC-1800 will decode the PCM signal using Pro Logic. Results may vary between different analog recordings.

Re-EQ

By pressing the *Re-EQ* button on the remote control or on the front panel, you can activate the advanced Lucasfilm Re-EQ enhancement. Lucasfilm engineers developed a patented frequency contouring equalization to accurately translate the sound from the movie theater environment into the home, correcting for significant tonal and spatial discrepancies between these environments. This enhancement is meant for film soundtracks only and is not beneficial for music playback.

AVC-1800 On-screen Display

The on-screen display (OSD) provides operational status of your AVC-1800 including selected Input Source, Digital Input, Surround mode, Dynamic Range, Dialog Normalization, and Volume level. According to Dolby requirements, Dialog Normalization is not defeatable. The on-screen display will indicate **DIALOG NORM: ON** when it has been encoded into the Dolby Digital bitstream. The on-screen display does not include tuner functions. The NTSC/PAL switch must be set properly for correct synchronization of the on-screen display.

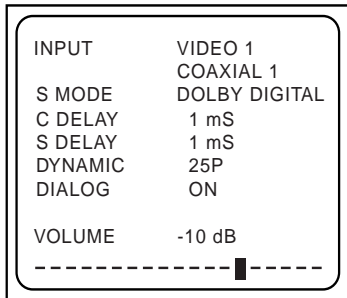

Press the *Display* button once to show selected source, digital input, surround mode, delay times, dynamic range, dialog normalization, and volume.

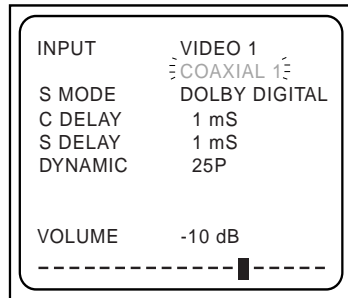

On-screen display with flashing digital input indicating that a digital signal is not being received.

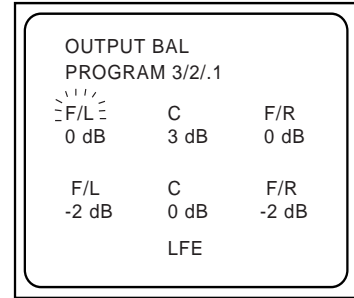

Press the *Display* button twice to show channel levels and program encoding method.

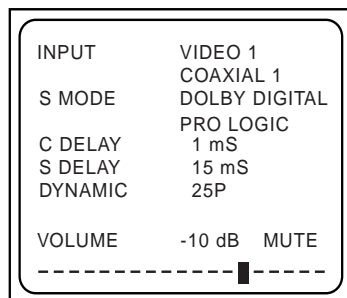

On-screen display indicating a Pro Logic (3/1) encoded signal and Mute engaged.

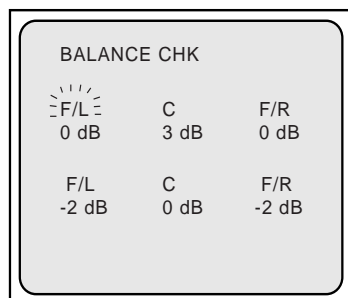

On-screen display in the calibration mode. Channel under adjustment flashes. Press the *Cal* button to advance to next channel.

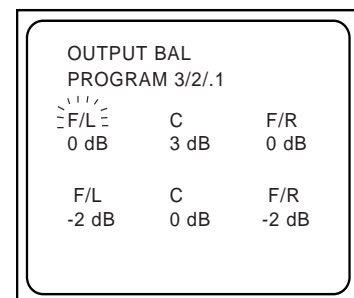

On-screen display in the Trim mode. Channel under adjustment flashes. Press the *Trim* button to advance to next channel.

Placement of Your Home Theater Speakers

Speaker Placement

Proper speaker placement is essential for optimum performance of your home theater system. The following are basic guidelines for speaker placement based upon idealized conditions. You may need to make placement compromises to allow for room shape, furniture placement, windows, doorways, and other considerations. The AVC-1800 permits electronic compensation when asymmetrical speaker placement is required.

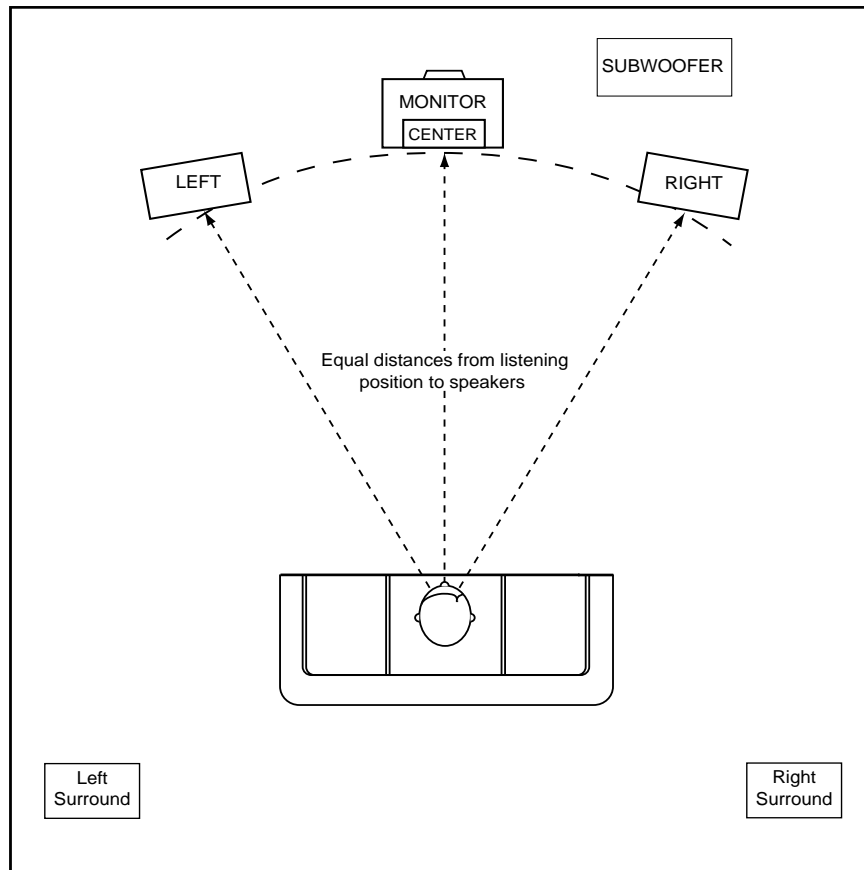

Typical home theater setup using conventional surround speakers. In this example, all three front speakers are the same distance to the listening area.

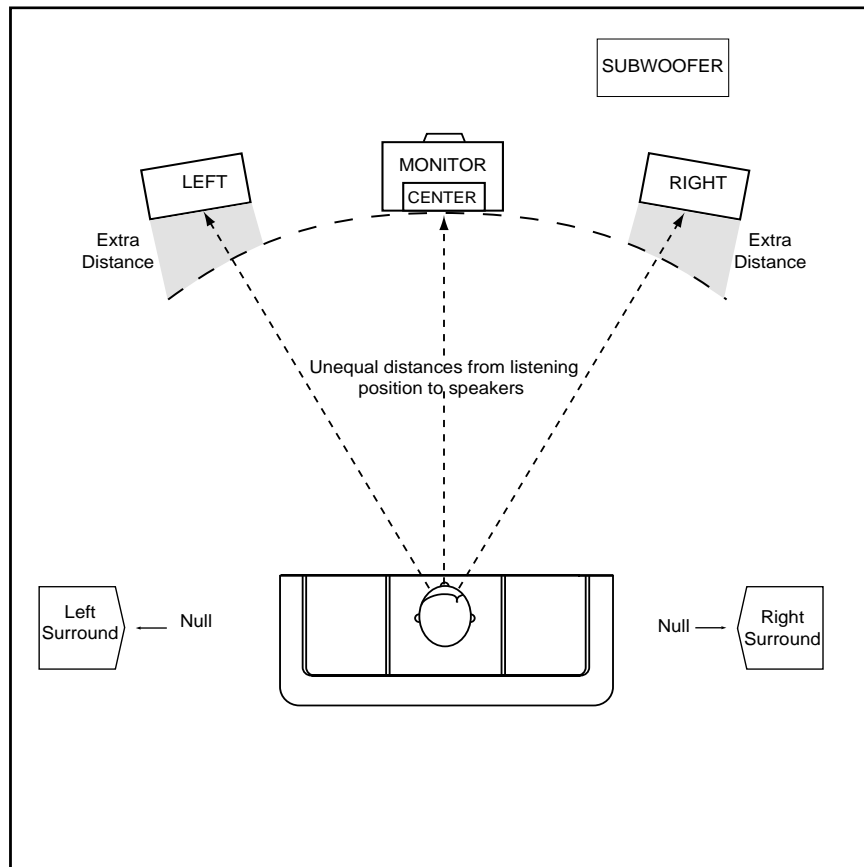

Alternate home theater setup. In this example, the center speaker is on the same plane as the left and right speakers and is therefore closer to the listening position. Time alignment can be corrected with center delay. Also shown is the position of dipole surround speakers.

Front Speakers

Try to locate your front left and right speakers an equal distance to the right and left of your monitor or projection screen. Ideally, your listening position should be at one point of an equilateral triangle with the left and right speakers at the other two points. To achieve what is commonly called the “sweet spot,” your left and right speakers might sound better facing forward or slightly toed-in, depending on their dispersion characteristics, room reflections, and the number of people in the room.

Center Speaker

The center speaker’s main function is to reproduce most of the cinema dialog and blend the sonic image from your speakers with the visual image on the screen. It is best to place your center speaker directly above or below the monitor, as close to the same height as the left and right speakers as possible. Be sure your center speaker is shielded to prevent discoloration of the picture tube. If you have a projection screen that is perforated to allow sound to pass through, you should locate the center speaker behind the screen at the same vertical plane as the left and right speakers. The distance from your preferred listening position to the center channel speaker should be the same as the distance from your listening position to the left and right speakers. You can accomplish this by measuring the distance to a left or right speaker and then locating the center speaker the same distance away from the listening position. If you cannot move your center channel behind the plane of the left and right speakers, you can compensate for its shorter distance electronically with the center delay adjustment. The purpose of physical placement or electronic adjustment assures the sound from all three front speakers will arrive at your listening position at the same time.

Conventional Surround Speakers

Surround speaker placement is a little more flexible than the front speakers are. Although 5.1 channel processing offers discrete surround channel information, movie soundtracks use the surround channels more for creating an ambient effect than for defining precise sonic images. To avoid drawing your attention from the action on the screen and enhance the blend of sound and picture, you should not be able to localize the sound coming from your surround speakers except during certain special effects. Therefore, you should try to avoid pointing the surround speakers directly toward your listening position and place them behind you and above your ear level when you are seated. You should be prepared to experiment with surround speaker placement for optimum results.

Dipole Surround Speakers

If you are using front and rear firing dipole surround speakers, locate them above and to the sides of your listening area. This deliberately places you in the “null” of the dipole speakers to minimize localization of the surround speakers. Refer to the owner’s manual of your speakers for further information in locating dipole speakers.

Subwoofer

Because of their long wavelengths, low bass frequencies are critically dependent on room placement to avoid bass-robbing standing waves or null points. Sometimes moving a subwoofer a few inches makes the difference between thin, weak bass and room shaking, foundation rattling bass.

One of the most reliable methods to correctly position your subwoofer is to first hook it up and place it next to your listening position. While it is playing music or a movie with strong bass in it, slowly walk around the various room locations where the sub could be located. You should be able to find a place where you hear balanced bass without excessive boominess. Once you have found this optimum location, simply move the subwoofer there. If you change your listening position, you should repeat this procedure.

If you are unable to place the sub where it sounds best, you might improve its sound by turning the sub’s cabinet to one side or the other.

Setting up your AVC 1800

Bass Management

Bass management is designed to assure overall balanced response by accommodating many different types of speaker systems that may or may not be able to reproduce frequencies below 80 Hz. The Bass Management setup menu lets you configure your speakers to reproduce low frequencies below 80 Hz, or to filter out these frequencies and route them to your front speakers or only to your subwoofer channels. The AVC-1800 has four toggle switches that you must set according to the characteristics of your speakers.

To Setup Bass Management for Your Front Left and Right Speakers:

1. Refer to the owner's manual of your front left and right loudspeakers to determine whether they are designed to reproduce low frequencies below 80 Hz.
2. If the main (Left and Right) speakers were designed to handle frequencies below 80 Hz, set the switch to *Large*. The front left and right speakers will then operate full range (20 Hz to 20 kHz).
3. If they were not designed for low frequencies, select *Small*. The front left and right speakers will then have low frequencies rolled off at 12 dB per octave starting at 80 Hz. This filtered low frequency information is then re-routed to the subwoofer channel.

To Setup Bass Management for Your Center Speaker:

1. Refer to the owner's manual of your center loudspeaker to determine whether it is designed to reproduce low frequencies below 80 Hz.
2. If the center speaker is designed to safely reproduce frequencies below 80 Hz, select *Large*. The center speaker will then operate full range (20 Hz to 20 kHz).
3. If it is not designed for low frequencies, select *Small*. The center speaker will then have low frequencies rolled off at 12 dB per octave starting at 80 Hz. This filtered low frequency information is then re-routed to the subwoofer channel.
4. If you do not have a center channel speaker, select *NONE* and the AVC-1800 sends center channel information into the left and right speakers to create a phantom center image.

To Setup Bass Management for your Surround Speakers:

1. Refer to the owner's manual of your surround loudspeakers to determine whether they are designed to reproduce low frequencies below 80 Hz.
2. If they are designed to safely reproduce frequencies below 80 Hz, select *Large*. The surround speakers will then operate full range (20 Hz to 20 kHz).
3. If the surround speakers are not designed for low frequencies, select *Small*. The surround speakers will have low frequencies rolled off at 12 dB per octave starting at 80 Hz. This filtered low frequency information is then re-routed to the subwoofer channel.

To Setup Bass Management for Your Subwoofer:

1. Select *LPF* (Low Pass Filter) if you are using a subwoofer to activate the built in electronic lowpass filter at 12 dB per octave at 80 Hz. For this setting, make sure the passive low pass crossover in your powered sub is defeated, since the electronic crossover in the AVC-1800 is likely to be more accurate. If your subwoofer has no switch to bypass or defeat its crossover, set it to its highest crossover frequency to minimize "double filtering".
2. Select *Off* if you are not using a subwoofer. Low frequency effects (LFE) are then evenly distributed to the Main, Center, and Surround speakers depending on their bass management settings.
3. Select *300 Hz* if you want to use the low pass filter built into your powered subwoofer. This setting effectively shifts the AVC-1800's low pass filter up, thereby minimizing "double filtering".

Calibrating Channel Levels

Manual calibration requires independent adjustment of the output level for each of the six channels of your AVC-1800 so that all channels have the correct signal strength at your actual listening position. The AVC-1800 has an internal pink noise generator that you can manually advance from channel to channel.

If you wish, you can calibrate your system with the aid of a sound pressure level (SPL) meter such as the Realistic Sound Level Meter (Radio Shack catalog # 33-2050). When you use an SPL meter for calibration, you should hold it upright directly in front of your head and make adjustments while you are seated in your listening position. If an SPL meter is unavailable, you can still adjust levels by ear with satisfactory results.

1. Press and hold the *Cal* button on the remote control until the screen turns red and the six channels and their levels appear in the on-screen display. The noise generator will automatically start with the L channel.
2. Each time you press the *Cal* button, it will advance to the next channel in the order of L, C, R, LS, RS, Sub. Note: If you have selected *Center None* or *Sub Off* with the bass management switches, they will be deleted from the display.
3. Press *Volume* Δ or ∇ buttons to adjust that channel to the desired level. The noise generator will not advance to the next channel until you are finished setting the channel level.
4. After the Sub channel has been calibrated, the next time you press the *Cal* button, it will terminate the calibration procedure, turn off the noise generator, and the calibrated settings will be stored into memory.

Assigning Digital Inputs to Sources

You can assign any of the four digital or analog inputs to any of the AVC-1800's seven input sources. For example, you may want match *Video 1 Source* with audio from *Digital Coaxial Input 1* from your DVD player. The AVC-1800 memorizes the last selected digital input to the source input. When you select the input again, it will automatically select the last stored digital input. You can also store the Pro Logic surround mode to analog sources.

Programming a Digital Input to Source Inputs

1. Select the input source you want to automatically link to a digital input.
2. Select the digital input you want to assign to that input source with the *Digital* button on the front panel or remote control.
3. The AVC-1800 will recall that digital input the next time the input source is selected

To Calibrate the Center Channel Delay Time:

1. Measure and write down the distance in feet from your listening position to your Left, Right, and Center channel speakers.
2. Note how much shorter the distance is to the Center speaker.
3. For each foot of distance, press the *C Delay* button on the front panel one time. Each mS of delay corresponds to one foot of distance, from 0 to five feet.
4. Once set, there is no reason to readjust the center channel delay.

Analog Input Level Adjustment Procedures

Analog Input Level Adjustment sets the incoming signal level to prevent distortion caused by overloading the input of the internal analog circuitry. You can adjust the analog input level from -10 dB to 0 dB. Press the *Input* \triangleright button on the remote control to increase the level to the analog input circuitry. Press the *Input* \triangleleft button to decrease the level to the analog circuitry. If the Overload LED illuminates, be sure to turn the input level down to prevent distortion.

Programming the Learning Remote Control

The Parasound universal remote control for the AVC-1800 can control up to six additional Audio/Video components. It is preprogrammed to operate the Parasound AVC-1800 Audio Video Controller main and remote zones and Parasound CD players. You can also program codes from five additional components under the *DVD*, *SAT*, *TV*, *VCR*, and *CBL* buttons. Red LEDs located under the under each of the device buttons and a tri-color status indicator in the top left hand corner of the remote control provide visual feedback while programming the remote control.

The preprogrammed codes for the Parasound AVC-1800 Audio/Video Controller are accessible by pressing the *AVC* or *ZONE* button. Pressing the *CD* button accesses the codes for Parasound CD players. You can program over the resident Parasound codes if you wish, and they can be easily restored if necessary. You can program infrared commands from another component's original remote control into any button under any device's own "page" of the Parasound universal remote control. Only the *Light* button cannot be re-programmed.

Battery life for the universal remote is approximately four months with average use. If components become unresponsive to commands from the remote, it usually means that the four "AAA" batteries need replacing. Be sure to reinstall the new batteries within three minutes of removing the old ones to avoid losing stored functions.

Programming Codes into the Universal Remote Control

1. Place the universal remote and the donor remote face-to-face approximately three inches apart.
2. Select the page you want to program by pressing the corresponding device button such as *DVD* or *SAT*.
3. Press and hold down the Device button and the *Enter* button simultaneously, until the amber Status LED and the red LED behind the device button both illuminate.
4. Press and release the button you want to store a code into until the amber LED flashes.
5. The red LED under the Device button turns off to indicate that the button is ready for programming.
6. Press and hold down the button on the donor remote to send to the universal remote.
7. The universal remote acknowledges it is ready to store the code into memory by flashing green. Release the donor remote button and the LED will flash amber.
8. **Note:** Repeat step 7 until the LED flashes green twice and returns to solid amber.
9. Repeat Steps 1 through 8 for the remaining buttons to be programmed.
10. Once you have completed "teaching" new commands to buttons in the selected Device mode, you must save the programmed information. Press and hold the device button and *Enter* button simultaneously again. The amber status LED flashes twice and turns off to indicate the commands were stored into memory.
11. Repeat steps 1-10 to program remote control codes into other pages into the universal remote control.

Erasing a Single Command within a Page

1. Press and hold the device button and *Enter* buttons simultaneously until the amber status LED and the device button turn on and remain lit.
2. Press the button that is to be erased on the universal remote control until the amber status LED flashes continuously.
3. Press the *Light* button. The status LED will flash green then turn to steady amber.
4. Repeat steps 2 and 3 for any other buttons to be erased in the selected device mode.
5. To exit, press and hold the device button and the *Enter* buttons simultaneously, again. The amber status LED flashes twice, turns off, and returns to normal.

To Erase All the Programmed Commands within a Page

1. Press and hold the device button and *Enter* buttons simultaneously until the amber status LED and the device button turn on and remain lit.
2. Press and hold the *Light* button for five seconds. The status LED will flash red five times, flash green twice and return to steady amber.
3. To exit, press and hold the device button and the *Enter* buttons simultaneously, again. The amber status LED flashes twice, turns off, and returns to normal.

To Erase All the Learned Commands in all Pages

Caution: This procedure permanently erases all commands programmed into the remote and restores default codes.

1. Press and hold the *TV Device* button and the *Light* button simultaneously for 10 seconds. The red Status LED will flash continuously. The status LED will then flash green twice, amber then turn off to indicate that all of the learned commands on the remote control have been erased.

To Restore Preprogrammed Codes for the AVC-1800 Page

1. Press and hold the *AVC* button and the *Mute* button simultaneously. The red Status LED and the LED behind the *AVC* button will illuminate.
2. Press 10, 10, and 1. The *AVC* and Status LED will flash once with each button press.
3. Press the *AVC* button again. The *AVC* and status LED will flash twice to indicate the preprogrammed codes were restored.

Programming Macros into the Learning Remote Control

Each of the five macro buttons (*DISPLAY*, *M1*, *M2*, *M3* and *M4*) can transmit up to 10 commands with one press of a button. Macro buttons can be used to facilitate one touch operation of your home theater system. For example, you can program the *M1* button to turn on the *AVC-1800* and all of your other source components then issue a play code for your DVD player.

The five macro buttons operate independently in two groups of device buttons on the remote control. The first group consists of the upper row of device buttons (*AVC*, *CD*, *DVD*, *AUX*). The second group consists of the lower row of device buttons (*SAT*, *TV*, *VCR*, *CBL*). Program the Macro buttons for the upper group with the *AVC* device button. Once programmed, you can activate any of the macro buttons while in any of the upper row of device pages (*AVC*, *DVD*, *CD*, and *AUX*). However, you cannot activate macros programmed in the upper row while any of the lower pages are activated.

Program the Macro buttons for the lower group with the *SAT* device button. Once programmed, you can activate any of the macro buttons while in any of the upper row of device pages (*AVC*, *DVD*, *CD*, and *AUX*). However, you cannot activate macros programmed in the lower row while any of the upper pages are activated.

Programming Macro Buttons

1. Press and hold the upper or lower row device button (*AVC* or *SAT*) and the *Mute* button simultaneously until the red status LED and the device button both remain lit.
2. Press the macro button you wish to program. (*POWER*, *M1*, *M2*, *M3* or *M4*)
3. Select and press up to 10 buttons for commands you want to store in the macro. Pressing a device button to change device modes is counted as one command.
4. Press the *Digital* or *Surround* button to save the selection. The red status LED and the device Button will blink twice to confirm the programming and then turn off.
5. Since the *DISPLAY* button is also a macro button, in order to add a Power (*On/Off*) command to the macro during programming you must press the *Input Level* < button in place of the On-Off button. (The remote knows that you want an on-off code.)
6. Since the *Digital* and *Surround* buttons are used in the programming sequence, these buttons cannot be used in a macro.

Erasing Macros

1. Press and hold the *AVC* or *SAT* device button and *Mute* buttons simultaneously until the red status LED and the device button turn on and remain lit.
2. Press the macro button to be erased on the universal remote control.
3. Press the *Digital or Surround* button. The red status and device LEDs will flash twice and turn off.
4. Repeat steps 2 and 3 for any other buttons to be erased in the selected device mode.
5. To exit, press and hold the device button and the *Enter* buttons simultaneously, again. The amber status LED flashes twice, turns off, and returns to normal.

Operating Your AVC-1800

Congratulations. Now that you have completed the setup procedures, you are ready to sit back and really enjoy your AVC-1800. Following are typical operating instructions for viewing a film, listening to music, using the tuner, or operating the remote zone.

Viewing a Film

1. Turn the power on to your AVC-1800, source equipment, and power amplifiers. If your associated equipment incorporates DC triggering, the AVC-1800 may turn on the other equipment for you.
2. Use the direct access *Source* buttons on the remote or the *Source* buttons on the front panel to select the video source input that you want to view.
3. Select the corresponding digital or analog input for the input source component you are playing and the Surround mode. If you have preprogrammed the digital input into the input source, the AVC-1800 will recall this setting for you.
4. Load a DVD, laser disc, or videotape into your video component, and start the film.
5. Adjust the *Volume* control to a level that suit your tastes and enjoy the film.

Listening to a Recording

1. Turn the power on to your AVC-1800, source equipment, and power amplifiers. If your associated equipment incorporates DC triggering, the AVC-1800 may automatically turn on the other equipment for you.
2. Use the direct access *Source* buttons on the remote or the *Source* buttons on the front panel, select the input source that you want to hear.
3. Select the corresponding digital or analog input for the input source component you are playing and the Surround mode. If you have preprogrammed the digital input into the input source, the AVC-1800 will recall this setting for you.
4. Load a CD or other media, into your audio component, and start playback.
5. Adjust the *Volume* control to a level that suit your tastes and enjoy the music.

Using the Tuner

Storing up to 29 Radio Stations into Preset Memory

1. In the auto or manual tuning mode, use the *Tune* ◀ or ▶ and *FM/AM* buttons on the front panel or remote control to tune to the radio frequency you want to store into preset memory.
2. Press the *Mem* button on the remote control. **MEMORY** and **CH** will flash in the tuner display for five seconds.
3. Use the numerical keys to select the preset number you want for that station to be stored into. To access preset numbers above **10**, press the numerical button down again to add **10** and again to add another **10**. For example, to access preset **15**, press the numerical button number **5** twice. Press **5** three times to store preset **25**.
4. After three seconds, the display stops flashing and the station is stored into preset. Note: the preset number will also turn off even though it has been stored into memory.
5. Repeat the process for as many stations as you want to store into preset memory.

Note: You can store your favorite stations into multiple preset numbers so they will be readily available when you use the *Preset* ◀ ▶ buttons.

Front Panel Operation

Selecting Preset Radio Stations from the Front Panel

1. Activate the tuner by pressing the *Tuner* button on the front panel.
2. Press the *Preset* button to advance to the next desired preset. If there is no broadcast frequency stored into a preset number, that number will be skipped.

Automatic Tuning from the Front Panel

1. Activate the tuner in the automatic tuning mode by pressing the *Tuner* button on the front panel and the *Man* button the remote control until **AUTO** appears in the tuner display.
2. Search through the previous or next broadcast frequency by pressing the *Tuning* ◀ or ▶ buttons to select the desired station.

Remote Control Operation

Selecting Preset Radio Stations from the Remote Control

Option 1

1. Activate the tuner by pressing the *Tuner* button on the remote control.
2. Press the *Preset* ◀ or ▶ button to scroll up or down through preset stations.

Option 2

1. Press the *Tuner* button on the remote control to activate the tuner.
2. Press any of the 10 preset numbers to select the radio station preset to that number.
3. To access preset numbers above **10**, press the numerical button down again to add 10 and again to add another 10. For example, to access preset **15**, press the numerical button number 5 twice and **P15** will be selected.

Manual Tuning from the Remote Control

1. Press the *Tuner* button on the remote control to activate the tuner.
2. Press the *Man* button.
3. Press the *Tune* ◀ or ▶ buttons to tune to the desired frequency. In the manual tuning mode, these buttons select FM frequencies in 100 kHz steps (50 kHz steps for export units) and AM frequencies in 10 kHz steps (9 kHz for export units)

Temporary Level Adjustment Using the Trim Function

After initial calibration, the *Trim* button on the remote control allows you to make temporary channel volume adjustments. Since there is no reason to trim the LS and RS channels separately after calibration, their adjustment is combined for your convenience.

To Trim Individual Channel Levels

1. Press the *Display* button twice to display the level indicators in the on-screen display.
5. Press the *Trim* button on the remote control. F/L flashes in the on-screen display to indicate that the front left channel is ready to adjust.
6. Each time you press the *Trim* button, it advances to the next channel in the order of **F/L**, **C**, **F/R**, **L/S**, **R/S**, and **SUB**.
7. Press *Volume* △ or ▽ buttons to adjust that channel to the desired level. You can adjust each channel level from 10 dB to +10 dB. After the Sub channel level has been trimmed, the next time you press the *Trim* button, it will end the trim function.

Operating the Remote Zone

From the Main Zone

1. Press the *Zone* button to control the remote zone from the remote control. There is a separate set of codes for the remote zone that you can access in the *Zone* “page”.
2. Refer to the drawing on page 16 for remote zone functions. **When *Zone* is selected, the *On* button controls both *On* and *Off* for the remote zone.**
3. When you control the AVC-1800 from the *Zone* page on the remote, only the remote zone can be controlled. The main zone remains unaffected until the *AVC* button is pressed again.
4. When the remote zone has been activated by pressing the *On* button, the *Active* LED will illuminate. When remote zone commands are issued, the *Zone* LED illuminates for about five seconds, indicating that you can make adjustments to the remote zone while the LED is on.
5. After five seconds, the LED will go out and control reverts back to main zone operation.

From the Remote Zone

1. In order to control the AVC-1800 from the remote zone, you must first install an infrared transmission system such as a Xantech. This includes installing a receiving eye in the remote zone and connecting a 1/8” mini jack into the *Zone External Remote* input on the rear panel of the AVC-1800.
2. Press the *Zone* button to control the remote zone from the remote control. There is a separate set of codes for the remote zone that you can access in the *Zone* “page”.
3. While controlling the AVC-1800 from the *Zone* page, the *On* button controls both *On* and *Off* for the remote zone. However, the *Volume* buttons, *Mute* button, and the *Input Selector* buttons operate in the same way as in the main zone.
4. The AVC-1800 has only one tuner section. Therefore, if you select a station or station preset from the remote *Zone*, it will also change the station in the main *Zone*.
5. When the remote zone has been activated by pressing the *On* button, the *Active* LED will illuminate. When remote zone commands are issued, the front panel *Zone* LED illuminates for about five seconds indicating the remote zone is being controlled.
6. Five seconds after making your adjustments to the remote zone, the AVC-1800 front panel and on-screen displays revert to main zone indication.

Maintaining Your AVC-1800

Your AVC-1800 requires no periodic maintenance and has no user serviceable parts inside. To avoid the risk of electric shock, do not remove the top cover. Clean the chassis with a soft cloth moistened only with window cleaner or clear water. Never use solvents or abrasives.

In Case of Trouble

Call your Parasound dealer who should be able to suggest simple diagnostic tests you can easily perform. If you determine that your AVC-1800 should be serviced, Contact Parasound or an Authorized Parasound Warranty Center for inspection and possible servicing.

Returning your AVC-1800 to Parasound for Service (USA Only)

If we determine that you should send your AVC-1800 to Parasound, you will need to obtain a Return Authorization (RA) number. The RA number must be clearly marked on the outer carton only. Ship the unit with adequate insurance and a copy of your purchase receipt inside to validate your warranty. Warranty repairs will only be performed by Parasound or authorized warranty centers on sets where your purchase receipt is from an Authorized Parasound Dealer or Parasound Reseller. Units purchased from unauthorized dealers are not eligible for warranty repair. Units that arrive without an RA number, without a suitable shipping carton or with evidence of improper internal packing materials may be refused. We do not accept collect shipments. After repair under warranty, the unit will be returned to you via prepaid UPS within the Continental United States. In the case of a non-warranty repair, contact us and we will advise you of the repair charges before you ship the unit to us. The same packing and Return Authorization number requirements apply.

Button Assignment Worksheet for the Learning Remote

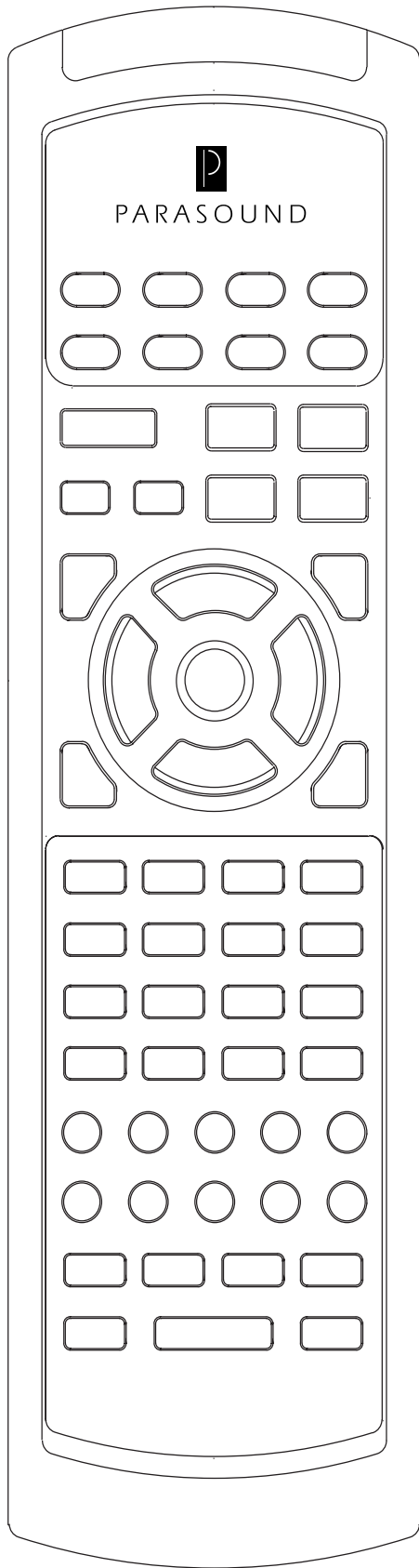

Component _____

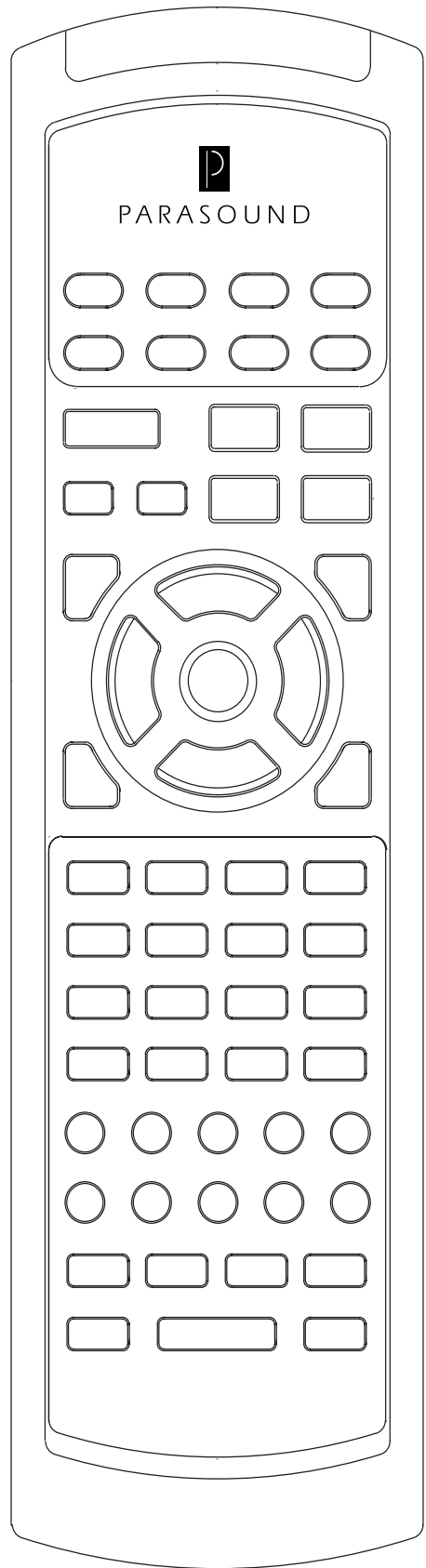

Component _____

Instructions: Write down stored codes into the blank buttons for each component

Button Assignment Worksheet for the Learning Remote

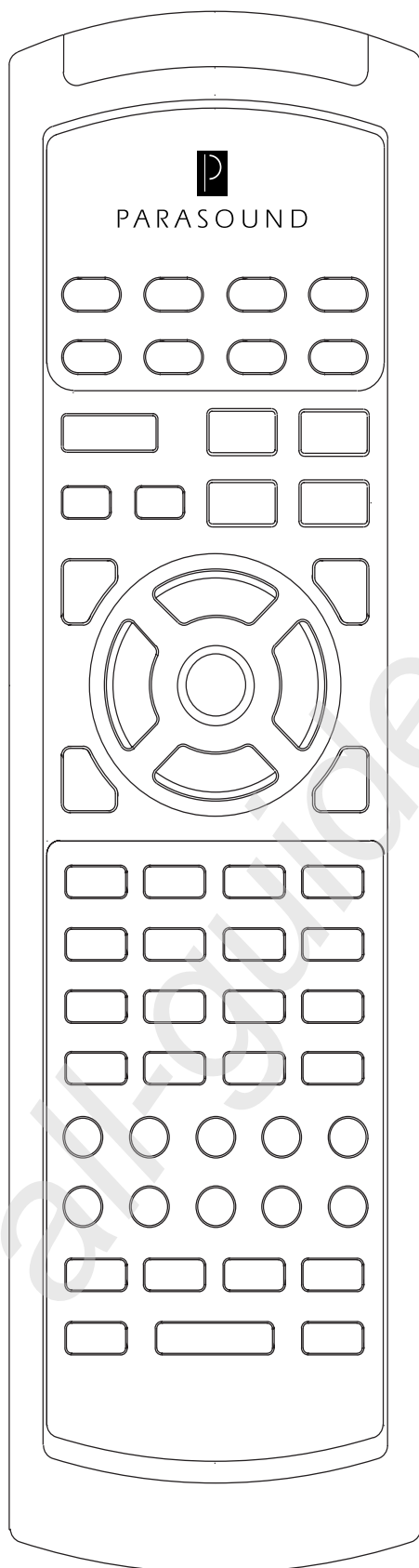

Component _____

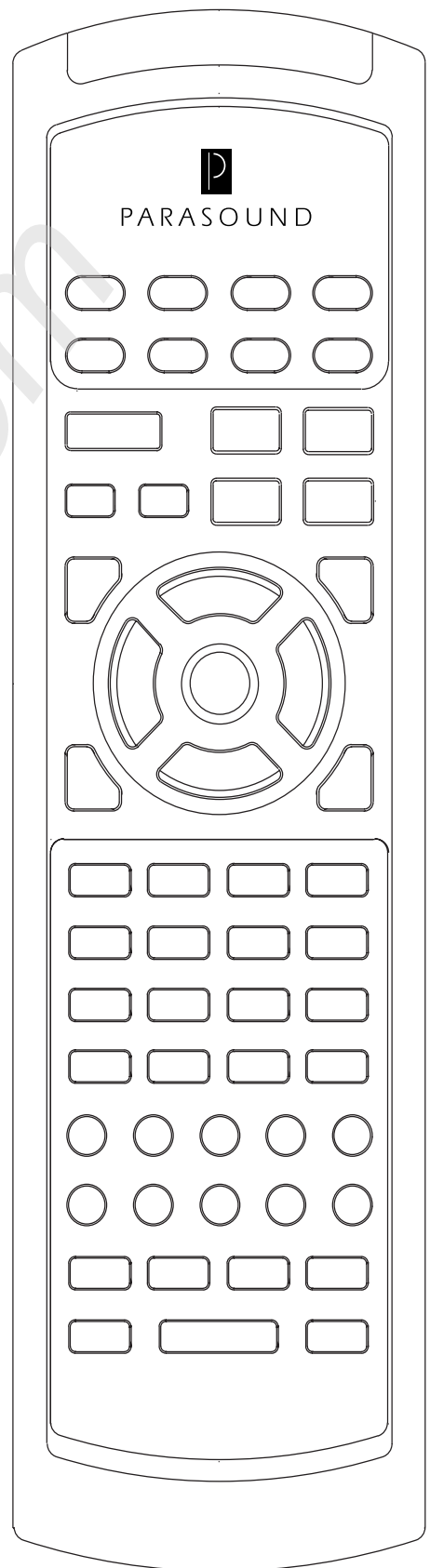

Component _____

Instructions: Write down stored codes into the blank buttons for each component

Button Assignment Worksheet for the Learning Remote

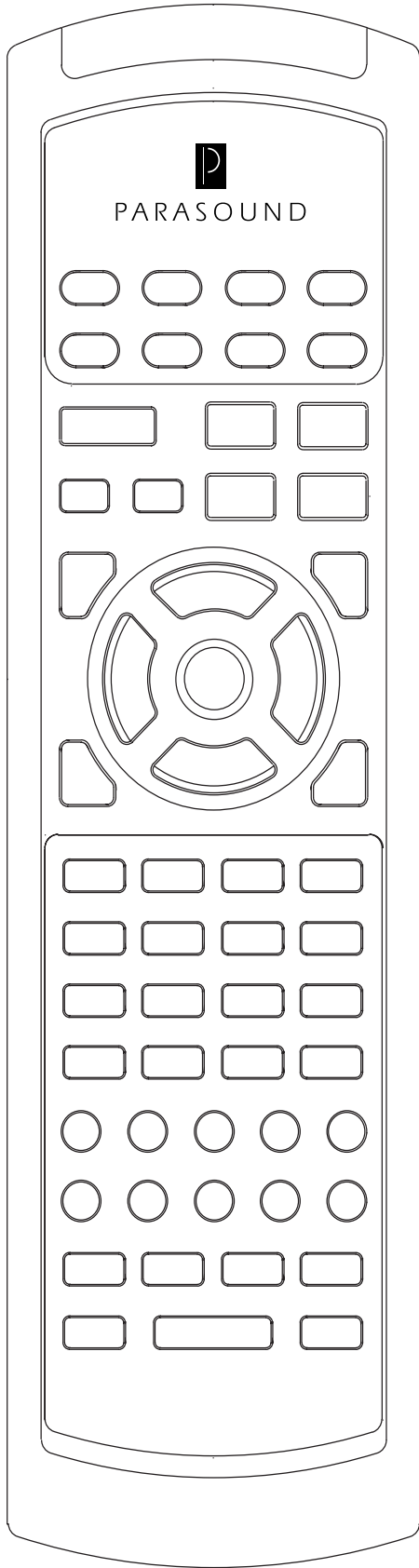

Component _____

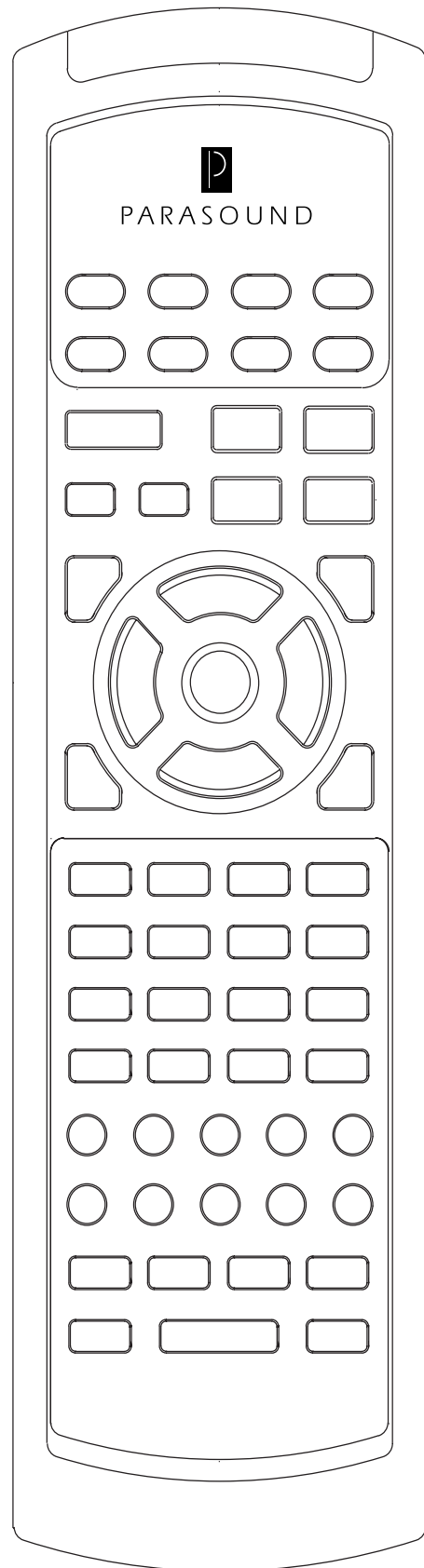

Component _____

Instructions: Write down stored codes into the blank buttons for each component

AVC-1800 Specifications

Frequency Response

Front (Large)	10 Hz-20 kHz
Front (Small)	80 Hz-20 kHz
Rear (Large)	10 Hz-20 kHz
Rear (Small)	80 Hz-20 kHz
Center (Large)	10 Hz-22 kHz
Center (Small)	80 Hz-22 kHz
Subwoofer (LPF)	10 Hz-80 Hz
Subwoofer (300 Hz)	10 Hz-300 Hz

Harmonic Distortion

Front	< 0.008 %
Center	< 0.008 %
Rear	< 0.008 %
Subwoofer	< 0.008 %

Input Impedance

Analog Inputs	10 k Ω
Coaxial Digital Inputs	75 Ω

IM Distortion

(1 kHz 1V Output)	
All Channels	< 0.06 %

Signal/Noise Ratio

(Flat/A-Weighted)	
Front	90 dB / 93 dB
Center	90 dB / 93 dB
Rear	75 dB / 82 dB
Subwoofer	85 dB / 93 dB

Video Section

(Output 1 V / 75 Ω Load)	
Sensitivity	1 V +/- 0.5 dB
Frequency Response	0.3 MHz -10 MHz +/- 1 dB
Overload	2.5 V P-P

Dimensions

17 1/8" wide x 4 1/2" high x 13" deep 5 7/8" high with feet

Weight

15 lb

Power Requirements

110 V - 120 V 60 Hz AC, 60 W
220 V - 240 V 50 Hz AC, 60 W

Features and specifications subject to change without notice

AVC-1800 Tuner Specifications

Tuning Range

FM: 87.5 MHz to 108 MHz

AM: 520 kHz to 1610 kHz

FM Sensitivity

Mono IHF 11 dBf

Stereo IHF 37 for 50 dB of quieting

AM Sensitivity

IHF 10 uV/m

Signal to Noise Ratio

>74 dB Stereo 65 dBf IHF Weighted

FM Stereo Separation

50 dB @ 1 kHz

40 dB @ 10 kHz

FM Selectivity

80 dB

AM Selectivity

30 dB

FM Frequency Response

30 Hz to 15 kHz +/- 1 dB

AM Frequency Response

20 Hz to 4.5 kHz +/- 2 dB

Total Harmonic Distortion

FM Mono < 0.08 %

FM Stereo < 0.2 %

Total Harmonic Distortion

AM < 0.5 %

Capture Ratio

< 1.5 dB

AM Suppression

60 dB



PARASOUND

*Parasound Products, Inc. 950 Battery Street, San Francisco, CA 94111
415-397-7100 / FAX 415-397-0144 www.parasound.com*